

IND560 Weighing Terminal



METTLER TOLEDO

IND560 Weighing Terminal

METTLER TOLEDO Service

Essential Services for Dependable Performance of Your IND560 Weighing Terminal

Congratulations on choosing the quality and precision of METTLER TOLEDO. Proper use of your new equipment according to this Manual and regular calibration and maintenance by our factory-trained service team ensures dependable and accurate operation, protecting your investment. Contact us about a service agreement tailored to your needs and budget. Further information is available at www.mt.com/service.

There are several important ways to ensure you maximize the performance of your investment:

1. **Register your product:** We invite you to register your product at www.mt.com/productregistration so we can contact you about enhancements, updates and important notifications concerning your product.
2. **Contact METTLER TOLEDO for service:** The value of a measurement is proportional to its accuracy – an out of specification scale can diminish quality, reduce profits and increase liability. Timely service from METTLER TOLEDO will ensure accuracy and optimize uptime and equipment life.
 - a. **Installation, Configuration, Integration and Training:** Our service representatives are factory-trained, weighing equipment experts. We make certain that your weighing equipment is ready for production in a cost effective and timely fashion and that personnel are trained for success.
 - b. **Initial Calibration Documentation:** The installation environment and application requirements are unique for every industrial scale so performance must be tested and certified. Our calibration services and certificates document accuracy to ensure production quality and provide a quality system record of performance.
 - c. **Periodic Calibration Maintenance:** A Calibration Service Agreement provides on-going confidence in your weighing process and documentation of compliance with requirements. We offer a variety of service plans that are scheduled to meet your needs and designed to fit your budget.

© METTLER TOLEDO 2022

No part of this manual may be reproduced or transmitted in any form or by any means, electronic or mechanical, including photocopying and recording, for any purpose without the express written permission of METTLER TOLEDO.

U.S. Government Restricted Rights: This documentation is furnished with Restricted Rights.

Copyright 2022 METTLER TOLEDO. This documentation contains proprietary information of METTLER TOLEDO. It may not be copied in whole or in part without the express written consent of METTLER TOLEDO.

METTLER TOLEDO reserves the right to make refinements or changes to the product or manual without notice.

COPYRIGHT

METTLER TOLEDO® is a registered trademark of Mettler-Toledo, LLC. All other brand or product names are trademarks or registered trademarks of their respective companies.

METTLER TOLEDO RESERVES THE RIGHT TO MAKE REFINEMENTS OR CHANGES WITHOUT NOTICE.

FCC Notice

This device complies with Part 15 of the FCC Rules and the Radio Interference Requirements of the Canadian Department of Communications. Operation is subject to the following conditions: (1) this device may not cause harmful interference, and (2) this device must accept any interference received, including interference that may cause undesired operation.

This equipment has been tested and found to comply with the limits for a Class A digital device, pursuant to Part 15 of FCC Rules. These limits are designed to provide reasonable protection against harmful interference when the equipment is operated in a commercial environment. This equipment generates, uses, and can radiate radio frequency energy and, if not installed and used in accordance with the instruction manual, may cause harmful interference to radio communications. Operation of this equipment in a residential area is likely to cause harmful interference in which case the user will be required to correct the interference at his or her expense.







■ Declaration of Conformity is located on the documentation CD.

Statement regarding harmful substances

We do not make direct use of harmful materials such as asbestos, radioactive substances or arsenic compounds. However, we purchase components from third party suppliers, which may contain some of these substances in very small quantities.

Warnings and Cautions

- READ this manual BEFORE operating or servicing this equipment and FOLLOW these instructions carefully.
- SAVE this manual for future reference.

	 WARNING
	FOR CONTINUED PROTECTION AGAINST SHOCK HAZARD CONNECT TO PROPERLY GROUNDED OUTLET ONLY. DO NOT REMOVE THE GROUND PRONG.
	 WARNING
	NOT ALL VERSIONS OF THE IND560 ARE DESIGNED FOR USE IN HAZARDOUS (EXPLOSIVE) AREAS. REFER TO THE DATA PLATE OF THE IND560 TO DETERMINE IF A SPECIFIC TERMINAL IS APPROVED FOR USE IN AN AREA CLASSIFIED AS HAZARDOUS BECAUSE OF COMBUSTIBLE OR EXPLOSIVE ATMOSPHERES.
	 WARNING
	WHEN THIS EQUIPMENT IS INCLUDED AS A COMPONENT PART OF A SYSTEM, THE RESULTING DESIGN MUST BE REVIEWED BY QUALIFIED PERSONNEL WHO ARE FAMILIAR WITH THE CONSTRUCTION AND OPERATION OF ALL COMPONENTS IN THE SYSTEM AND THE POTENTIAL HAZARDS INVOLVED. FAILURE TO OBSERVE THIS PRECAUTION COULD RESULT IN BODILY HARM AND/OR PROPERTY DAMAGE.
 CAUTION	
BEFORE CONNECTING/DISCONNECTING ANY INTERNAL ELECTRONIC COMPONENTS OR INTERCONNECTING WIRING BETWEEN ELECTRONIC EQUIPMENT ALWAYS REMOVE POWER AND WAIT AT LEAST THIRTY (30) SECONDS BEFORE ANY CONNECTIONS OR DISCONNECTIONS ARE MADE. FAILURE TO OBSERVE THESE PRECAUTIONS COULD RESULT IN DAMAGE TO OR DESTRUCTION OF THE EQUIPMENT AND/OR BODILY HARM.	
	<i>NOTICE</i>
	OBSERVE PRECAUTIONS FOR HANDLING ELECTROSTATIC SENSITIVE DEVICES.

Disposal of Electrical and Electronic Equipment

In conformance with the European Directive 2012/19/EC on Waste Electrical and Electronic Equipment (WEEE) this device may not be disposed of in domestic waste. This also applies to countries outside the EU, per their specific requirements.



Please dispose of this product in accordance with local regulations at the collecting point specified for electrical and electronic equipment.

If you have any questions, please contact the responsible authority or the distributor from which you purchased this device.

Should this device be passed on to other parties (for private or professional use), the content of this regulation must also be related.

Thank you for your contribution to environmental protection.

Contents

1	Analog Output Option	1-1
1.1.	Specifications	1-1
1.2.	Analog Output Operation	1-2
1.3.	Installation	1-5
1.4.	Setup in the IND560 Terminal	1-6
1.5.	Wiring	1-8
1.6.	Analog Output Kit Spare Parts	1-9
2	A-B RIO Interface Option.....	2-1
2.1.	Overview.....	2-1
2.2.	Data Definition.....	2-3
2.3.	Hardware Setup	2-13
2.4.	Software Setup.....	2-14
2.5.	Troubleshooting	2-15
2.6.	Allen-Bradley RIO Interface Kit Part Numbers	2-16
2.7.	Interfacing Examples	2-17
3	DeviceNet™ Option	3-1
3.1.	Preface	3-1
3.2.	Overview.....	3-1
3.3.	DeviceNet Characteristics	3-1
3.4.	Data Definition.....	3-3
3.5.	Floating Point	3-7
3.6.	Hardware Setup	3-8
3.7.	Software Setup.....	3-9
3.8.	Troubleshooting	3-10
3.9.	DeviceNet Option Kit.....	3-11
3.10.	DeviceNet Commissioning and Configuration Examples.....	3-11
4	EtherNet/IP™ Interface	4-1
4.1.	Overview.....	4-1
4.2.	Data Definition.....	4-4
4.3.	Software Setup.....	4-10
4.4.	Troubleshooting	4-11
4.5.	EtherNet/IP Option Kit	4-12
4.6.	Programming Examples	4-13

5	Modbus TCP Interface	5-1
5.1.	Preface	5-1
5.2.	Overview.....	5-1
5.3.	Modbus TCP Characteristics	5-2
5.4.	Modbus TCP Board	5-2
5.5.	Data Definition.....	5-3
5.6.	Software Setup.....	5-10
5.7.	Troubleshooting	5-11
5.8.	Modbus TCP Option Kit	5-12
5.9.	Modbus TCP Configuration Example.....	5-12
6	PROFIBUS Option	6-1
6.1.	Overview.....	6-1
6.2.	Data Integrity.....	6-5
6.3.	Discrete Data.....	6-5
6.4.	Floating Point	6-7
6.5.	Shared Data	6-8
6.6.	Discrete Data I/O Space Usage Comparison	6-9
6.7.	IND560 PROFIBUS Message Mapping	6-11
6.8.	Controlling Discrete I/O Using a PLC Interface	6-16
6.9.	Hardware Setup	6-17
6.10.	Software Setup.....	6-17
6.11.	PROFIBUS Option Kit Part Numbers	6-19
6.12.	Interfacing Examples	6-20
A	Integer and Division Data Formats	A-1
B	Floating Point Format	B-1
B.1.	Operational Overview.....	B-1
C	PLC Data Sizes.....	C-1
C.1.	Introduction.....	C-1
C.2.	Integer and Divisions Data Formats	C-1
C.3.	Floating Point Data Format.....	C-2
D	ASCII Characters	D-1
D.1.	Standard Characters	D-1
D.2.	Control Characters	D-2

1 Analog Output Option

The Analog Output option kit provides an isolated 4-20 mA or 0-10 VDC analog signal output for displayed weight, ABS-displayed weight (absolute displayed weight), gross weight, rate or ABS-rate. The analog output uses a 16-bit D/A converter for a very precise output.

The Analog Output sub-block lets you select the data source for the analog signal and provides a method to calibrate the analog zero and high limit values. The IND560 terminal must be calibrated to the desired scale capacity before making Analog Output adjustments. If rate is to be used as the source for the analog output signal, it must be enabled in the **Scale > Rate** branch of setup. The Analog Output card provides one channel - it may be either current (4-20 mA) or voltage (0-10 VDC).

1.1. Specifications

Maximum Cable Length	0-10 VDC – 50 ft (15.2 m) 4-20mA – 1000 ft (300 m)
Min/Max Load Resistance	0-10 VDC – 100k ohms minimum 4-20 mA – 500 ohms maximum
Outputs	1 channel capable of supplying 4-20 mA or 0-10 VDC
Resolution	16 bit resolution - 65536 levels across entire range

- Note that if the load resistance ratings are exceeded, the analog output will not operate properly.
- Figure 1-1 shows an Analog Output Option Board with its connector at bottom center.

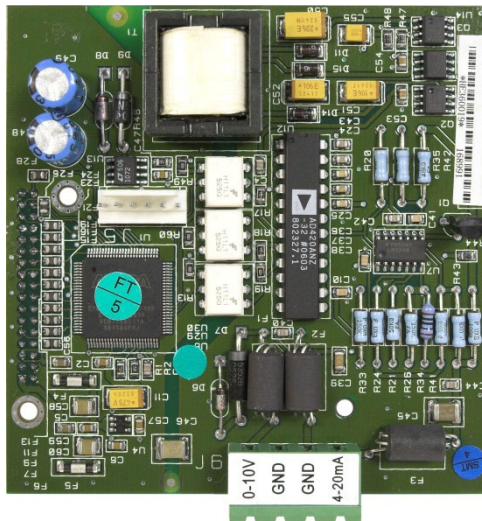

Figure 1-1: Analog Output Option Board

1.2. Analog Output Operation

When the source of the analog output is displayed weight, gross weight or rate, the output signals will be at the lower limit (0 VDC or 4 mA) when the value represented is at zero. When the value reaches its maximum limit, the output signal will increase to the high limit (10 VDC or 20 mA). Any value between zero and the maximum limit will be represented as a percentage of the output proportional to the percentage of the value.

The ABS (absolute)-displayed weight and ABS-rate are intended for use when material is being transferred off of a scale in Net mode. In these cases, the displayed weight and rate will show negative values, but the analog output signal will treat them as absolute values (disregarding their negative status). The output signals will increase as the interpreted absolute weight value or absolute rate value increases.

How the analog output functions under zero and over the high limit is determined by the selection for the source field selected – Displayed Weight, ABS – Displayed Weight, Gross Weight, Rate or ABS – Rate and the type of analog signal (4-20 mA or 10 VDC). Table 1-1 details how the analog output reacts under these conditions.

In order to use Rate as the source, it must be enabled in setup at **Scale > Rate**. For information on Rate configuration, refer to Chapter 3, Configuration, of the IND560 Technical Manual.





Table 1-1: Analog Output Functions by Source

Source = Displayed Weight, Mode = 4-20 mA	
Under Zero	When the displayed weight (gross or net) drops below zero, the analog signal continues to decrease. When the under zero display blanking point is reached, or the analog signal negative range is exceeded, the analog output immediately switches to approximately 0 mA and remains there until the display is no longer blanked or the analog signal returns to within range.
Over High Limit	When the displayed weight (gross or net) exceeds the high limit, the analog signal continues to increase. When the display blanking point is reached, or the analog signal positive range is exceeded, the analog output immediately switches to approximately 24 mA and remains there until the weight display is no longer blanked or the analog signal returns to within range.
Source = ABS – Displayed Weight, Mode = 4-20 mA	
Under Zero	As the ABS-displayed weight increases in value, the analog output signal will climb towards the maximum output (20mA or 10VDC). When the true under zero blanking point is reached, the analog output immediately switches to approximately 0 mA and remains there until the display is no longer blanked.
Over High Limit	Only possible when weighing in gross mode with ABS-displayed weight as the source. Works the same as the standard “Displayed Weight” setting in this case.
Source = Gross Weight, Mode = 4-20 mA	
Under Zero	When the gross weight drops below zero, the analog signal continues to decrease. When the under zero display blanking point is reached, or the analog signal negative range is exceeded, the analog output immediately switches to approximately 0 mA and remains there until the display is no longer blanked or the analog signal returns to within range.
Over High Limit	When the gross weight exceeds the high limit, the analog signal continues to increase. When the display blanking point is reached, or the analog signal positive range is exceeded, the analog output immediately switches to approximately 24 mA and remains there until the weight display is no longer blanked or the analog signal returns to within range.
Source = Rate, Mode = 4-20 mA	
Under Zero	When the rate drops below zero, the analog output quickly switches to approximately 0 mA and remains there until the rate returns to within the programmed range. The jump to 0 mA will occur only as quickly as the rate value is updated in the terminal. Rate update is based on Measurement Period and Output Average, selected in the terminal’s setup menu.
Over High Limit	When the rate exceeds the high limit, the analog output quickly switches to approximately 24 mA and remains there until the rate returns to within the programmed range. The jump to 24 mA will occur only as quickly as the rate value is updated in the terminal. Rate update is based on Measurement Period and Output Average, selected in the terminal’s setup menu.

Source = ABS - Rate, Mode = 4-20 mA	
Under Zero	Not applicable. ABS-Rate recognizes negative rate values as valid.
Over High Limit	When the rate exceeds the analog output high limit, the analog output quickly switches to approximately 24 mA and remains there until the rate returns to within the programmed range. The jump to 24mA will occur only as quickly as the rate value is updated in the terminal. Rate update is based on Measurement Period and Output Average, selected in the terminal's setup menu.
Source = Displayed Weight, Mode = 0-10 VDC	
Under Zero	When the displayed weight (gross or net) drops below zero, the analog signal continues to decrease. When the under zero display blanking point is reached, or the analog signal negative range is exceeded, the analog output immediately switches to approximately -2.4 VDC and remains there until the display is no longer blanked or the analog signal returns to within range.
Over High Limit	When the displayed weight (gross or net) exceeds the high limit, the analog signal continues to increase. When the display blanking point is reached, or the analog signal positive range is exceeded, the analog output immediately switches to approximately 12.5 VDC and remains there until the weight display is no longer blanked or the analog signal returns to within range.
Source = ABS – Displayed Weight, Mode = 0-10 VDC	
Under Zero	As the ABS-displayed weight increases in value, the analog output signal will climb towards the maximum output (20mA or 10VDC). When the true under zero blanking point is reached, the analog output immediately switches to approximately -2.4V and remains there until the display is no longer blanked.
Over High Limit	Only possible when weighing in gross mode with ABS-displayed weight as the source. Works the same as the standard "Displayed Weight" setting in this case.
Source = Gross Weight, Mode = 0-10 VDC	
Under Zero	When the gross weight drops below zero, the analog signal continues to decrease. When the under zero display blanking point is reached, or the analog signal negative range is exceeded, the analog output immediately switches to approximately -2.4 VDC and remains there until the display is no longer blanked or the analog signal returns to within range.
Over High Limit	When the gross weight exceeds the high limit, the analog signal continues to increase. When the display blanking point is reached, or the analog signal positive range is exceeded, the analog output immediately switches to approximately 12.5 VDC and remains there until the weight display is no longer blanked or the analog signal returns to within range.

Source = Rate, Mode = 0-10 VDC	
Under Zero	When the rate drops below zero, the analog output quickly switches to approximately -2.4 VDC and remains there until the rate returns to within the programmed range. The jump to -2.4 VDC will occur only as quickly as the rate value is updated in the terminal. Rate update is based on Measurement Period and Output Average, selected in the terminal's setup menu.
Over High Limit	When the rate exceeds the high limit, the analog output quickly switches to approximately 12.5 VDC and remains there until the rate returns to within the programmed range. The jump to 12.5 VDC will occur only as quickly as the rate value is updated in the terminal. Rate update is based on Measurement Period and Output Average, selected in the terminal's setup menu.
Source = ABS - Rate, Mode = 0-10 VDC	
Under Zero	Not applicable. ABS-Rate recognizes negative rate values as valid.
Over High Limit	When the rate exceeds the analog output high limit, the analog output quickly switches to approximately 12.5 VDC and remains there until the rate returns to within the programmed range. The jump to 12.5 VDC will occur only as quickly as the rate value is updated in the terminal. Rate update is based on Measurement Period and Output Average, selected in the terminal's setup menu.

1.3. Installation

	 WARNING
	DISCONNECT ALL POWER TO THIS UNIT BEFORE REMOVING THE FUSE OR SERVICING.
 WARNING	
DO NOT APPLY POWER TO THE IND560 TERMINAL UNTIL INSTALLATION OF COMPONENTS AND EXTERNAL WIRING HAS BEEN COMPLETED.	
	NOTICE
	OBSERVE PRECAUTIONS FOR HANDLING ELECTROSTATIC SENSITIVE DEVICES.

The analog output option for either enclosure type can be installed at the factory or it can be ordered as a kit and installed in the field. The option kit includes detailed drawings to assist in the installation.

The recommended wiring for the analog output is 2 conductor, 20 GA cable available from METTLER TOLEDO (part number 510220190). It is equivalent to Belden #8762.

1.4. Setup in the IND560 Terminal

Figure 1-2 illustrates the setup procedures for configuring the Analog Output option for the IND560 terminal.

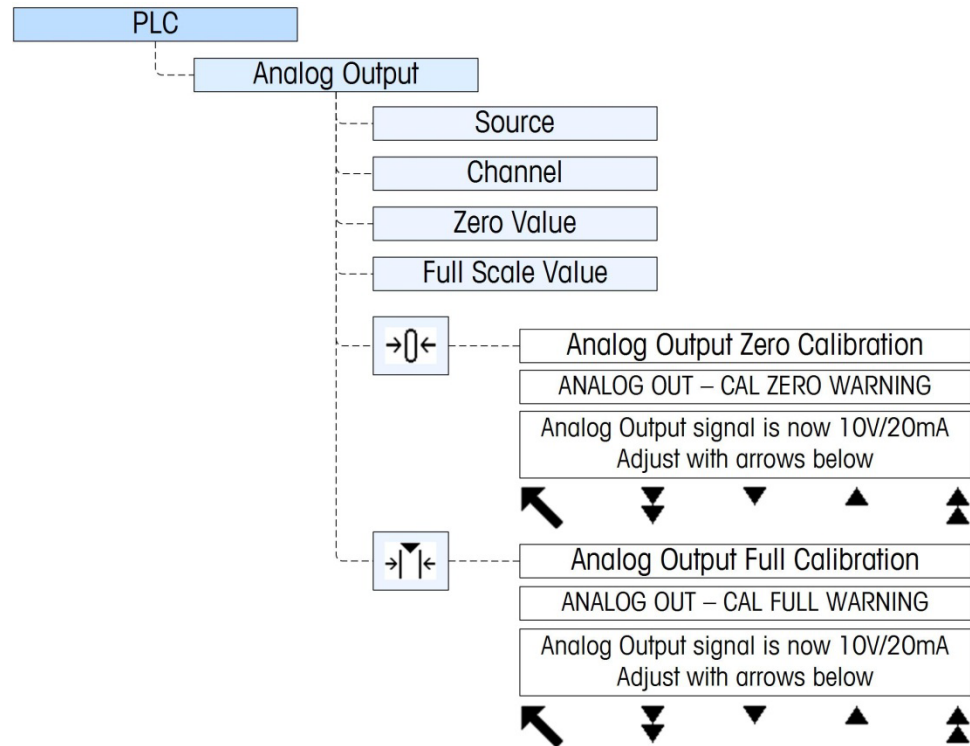

Figure 1-2: Setup Procedures for Configuring the Analog Output Option Card





1.4.1. Analog Output Setup Sub-Block

To configure the Analog Output Kit Option:

1. With power to the IND560 terminal removed, connect a volt or current meter to the appropriate output. If the customer's device is already connected, the meter is not necessary.
2. Apply power to the terminal and enter Setup. Navigate to PLC sub-block.
3. Select the Analog Output branch, then select the source. Choices are None, Displayed Weight (the default), Gross Weight, Rate. None disables the analog output. Displayed Weight outputs an analog signal based on the displayed net or gross weight. When Gross Weight is selected, the analog signal is based on the gross weight regardless of what the net weight might be. In order to be available as a source, Rate must be configured at **Scale > Rate**.
4. Next, select the Channel. Options are Scale and None. Scale is the only option available now; None is reserved for future use.
5. At the Zero Value prompt, enter the desired source value for which the analog output should be zero. Typically this would be "0" in most applications; however, any valid value below the high limit can be used.

6. At the Full Scale Value prompt, enter the desired source value at which the analog output should be at its high limit. For sources of weight, this would typically be scale capacity, but it could be lower. For rate, this should be the rate value that should provide a full analog output signal.
7. After all these parameters have been entered, the analog output can be adjusted to meet the customer's requirements using the ZERO softkey $\rightarrow 0 \leftarrow$ and the SPAN softkey $\rightarrow] \leftarrow$. To adjust the zero reference analog signal, press the ZERO softkey $\rightarrow 0 \leftarrow$.
8. Note that a display message is shown warning that during the adjustment, the analog output will be set to zero and will not monitor changes in the source value. Press the ESCAPE softkey **Esc** to exit the zero adjustment process or press the OK softkey **OK** to continue the adjustment process.
9. At the Analog Output - Cal Zero screen, use the softkeys to adjust the analog output signal to be exactly zero on the customer's device. The available softkeys are described in Table 1-2.

Table 1-2: Softkey Descriptions

	Coarse Down	This adjusts the analog signal level down in large steps.
	Fine Down	This adjusts the analog signal level down in small steps.
	Fine Up	This adjusts the analog signal level up in small steps.
	Coarse Up	This adjusts the analog signal level up in large steps.

10. When the zero adjustment is complete, press the EXIT softkey  to return to the Analog Output screen.
11. Now, the full scale analog output value can be adjusted by pressing the SPAN softkey $\rightarrow] \leftarrow$. A similar warning message will be shown indicating the analog output will be set to the high value and will not monitor changes in the source. Press the ESCAPE softkey **Esc** to exit the span adjustment process or press the OK softkey **OK** to continue the adjustment process.
12. At the Analog Output - Cal Full screen, use the softkeys to adjust the analog output signal to be exactly what the customer's device requires for its high limit. The available softkeys are described in Table 1-2.

1.4.1.1. Setting a Negative Value

It is sometimes necessary to set a negative value to define the lower end of the span. For example, the 4mA output might be set to correspond to a weight value of -20 kg.

It is not possible to set a negative weight value directly from the IND560 operator interface. However, there are two ways of setting a negative value:

- Use an external QWERTY keyboard connected to the terminal's (optional) USB port to enter the negative value in setup on the terminal, in the Analog Output Zero Value field.
- Enter the negative value directly into Shared Data variable ao0103 (Analog Output Zero Preset).

1.5. Wiring

WARNING
DO NOT APPLY POWER TO THE IND560 TERMINAL UNTIL INSTALLATION OF COMPONENTS AND EXTERNAL WIRING HAS BEEN COMPLETED.
WARNING
IF THIS DEVICE IS USED IN AN AUTOMATIC OR MANUAL FILLING CYCLE, ALL USERS MUST PROVIDE A HARD-WIRED EMERGENCY STOP CIRCUIT OUTSIDE THE DEVICE OF CIRCUITRY. FAILURE TO OBSERVE THIS PRECAUTION COULD RESULT IN BODILY INJURY.

The maximum recommended cable length for the 0-10 VDC output is 50 feet (15.2 meters). The maximum recommended cable length for the 4-20 mA output is 1,000 feet (300 meters). The recommended cable for use with the analog output is shielded two-conductor stranded 20-gauge cable (Belden #8762 or equivalent), which is available from METTLER TOLEDO using part number 510220190. See Figure 1-3 for connection and termination information.

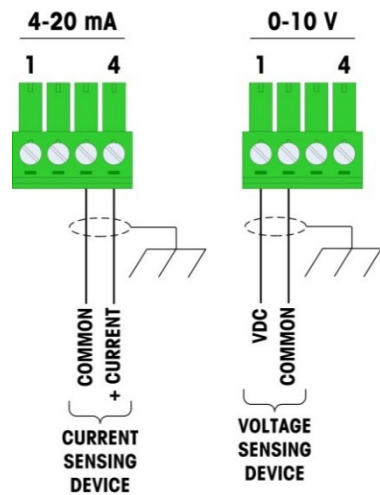

NOTES:

1. USE TWO-CONDUCTOR SHIELDED CABLE.
2. MINIMUM RESISTANCE OF DEVICE LOAD: 500 OHMS.
3. WIRE SIZE: 18 AWG (.823 mm²) MAXIMUM
24 AWG (0.205 mm²) MINIMUM.

Figure 1-3: Analog Output Kit Wiring Connections

1.6. Analog Output Kit Spare Parts

There are no associated spare parts with the Analog Output option kit. The kit number is 71209099. Table 1-3 shows what the kit contains.

Table 1-3: Analog Output Option Kit

Description	Qty.
Installation Instructions	1
PCB Package	1
Installation Kit	1
Gland Kit	1

2 A-B RIO Interface Option

- The Allen-Bradley RIO interface was discontinued in January 2021. Information provided in this manual is for the purpose of legacy installation support only.

2.1. Overview

The A-B RIO interface option kit enables the IND560 terminal to communicate to Allen-Bradley Programmable Logic Controllers (PLCs) through direct connection to the A-B RIO network. The option consists of a backplane-compatible I/O module and software that resides in the IND560 terminal, which implements the data exchange.

The A-B RIO interface for the IND560 has the following features:

- A-B RIO Node Adapter Chip Set (licensed from Allen-Bradley) and termination for the A-B network cable (blue hose) on a three-position removable terminal block.
- User programmable RIO communication parameters are configured in software set up through the terminal keyboard/display.
- Capability for bi-directional discrete mode communications of weight, display increments, status, and control data between the PLC and the terminal.
- Capability for bi-directional block transfer communication of many IND560 data variables.

Figure 2-1 shows an A-B RIO option board, with its connector at lower left.



Figure 2-1: A-B RIO Option Board

2.1.1. Communications

The IND560 terminal utilizes component parts that are provided by Allen-Bradley to ensure complete compatibility with the Allen-Bradley RIO network. An IND560 terminal is recognized as an RIO (Allen-Bradley) device by the PLC.

Each option connected to the Allen-Bradley RIO network represents a physical node. The connection is facilitated by a three-position removable terminal block on

the option card back panel. These terminals correspond to the terminals on the A-B PLC RIO connector.

The wiring between the PLC and the RIO connector uses the standard RIO cable used by Allen-Bradley (Figure 2-2). This cable is often referred to as “blue hose.” The cable installation procedures and specification including distance and termination requirements are the same as recommended by Allen-Bradley for the RIO network.

The communication baud rate of the IND560 terminal can be selected in the setup menu at **Communication > PLC > A-B RIO** (Figure 2-3).

2.1.2. Node/Rack Address

Although each RIO option represents one physical node, the addressing of the node is defined as a logical rack address. This address is chosen by the system designer, and then programmed into the IND560 and the PLC. The IND560’s address is programmed in the setup menu at **Communication > PLC > A-B RIO** in the setup menu. The IND560 address can be entered in either decimal or octal. Most PLC address entry is in octal.

Also within the setup menu of the IND560 are selections for the logical rack address, starting quarter, designation of the last rack, and the number of quarters (Message Slots). Quarters must be contiguous in a single, logical rack, so the starting quarter must be low enough to accommodate all of the required data for the scales in a single, logical rack. The IND560 will determine the number of quarters needed for the chosen data format and number of configurable Message Slots. It only allows selection of the possible starting quarters and maximum Message Slots.

2.1.3. Data Formats

The A-B RIO Kit option has two types of data exchanges: discrete data and block transfer data.

Discrete data is continuously available. The A-B RIO interface option has its own logical rack address to send and receive information to and from the PLC. Discrete data is always sent even when the optional block transfer data is used.

Block transfer data is available when the option is enabled through the IND560 **Communication > PLC > A-B RIO** setup menu. This data is used to pass information that cannot be sent by the discrete data because of size or process speed limitations. See the Data Definition section for more information.

2.2. Data Definition

The A-B RIO Kit option uses two types of data for its communication with PLCs: discrete data and block transfer data. Discrete data is always available. The data transfer is accomplished via the PLC's I/O messaging. Block transfer data is only available if this data option is enabled through the **Communication > PLC > A-B RIO** setup block (see Figure 2-3). If the block transfer data option is enabled, it is provided in addition to the discrete data. Block transfer data requires "block transfer" ladder sequence programming to accomplish the data transfer between the IND560 and PLC.

2.2.1. Data Integrity

The IND560 has specific bits to allow the PLC to confirm that data was received without interrupt and the IND560 is not in an error condition. It is important to monitor these bits. Any PLC code should use them to confirm the integrity of the data received for the IND560. Refer to data charts in Appendix A and Appendix B for specific information regarding the Data OK, Update in Progress, Data Integrity bits and their usage.

2.2.2. Discrete Data

There are three formats of discrete data available with the A-B RIO Kit option: integer, division, and floating point. Only one type of data format may be selected and used by all IND560's sharing the same A-B RIO logical rack address.

The format of discrete data will affect the amount of rack space required. Integer and division formats require one-quarter rack per IND560 Message Slot (two 16-bit words of input and two 16-bit words of output data). One IND560, with 1 Message Slot, would use a quarter rack. Two IND560s, with 1 Message Slot each, would use a half rack. Three IND560s, with 1 Message Slot each, would use three-quarters of a rack. Four IND560s, with 1 Message Slot each, would use a full rack.

The floating-point format requires more space per IND560 because floating point data uses two 16-bit words of data to represent just the numeric data alone. The floating point format uses one-half rack per IND560 Message Slot (four 16-bit words of input and four 16-bit words of output data).

Section of the appropriate format depends on issues such as the range or capacity of the scale used in the application. The integer format can represent a numerical value up to 32,767. The division format can represent a value up to 32,767 scale divisions or increments. The floating-point format can represent a value encoded in IEEE 754, single precision floating point format.

Floating point is the only format that includes decimal point information as a part of its data. All other formats ignore decimal points. Accommodation of decimal point location must take place in the PLC logic, when it is needed with these formats.

Another issue is the type of information communicated between the IND560 and PLC for the application. Because the floating point format has more space for its data, it has additional information that can be sent or received without using the optional block transfer data. Please see each format's detailed description of the data available to determine which is most suitable for the specific application.

2.2.2.1.

Examples

250 x .01 scale				
IND560 Displays:	0	2.00	51.67	250.00
Format sent:				
Integer	0	200	5167	25000
Division	0	200	5167	25000
Floating Point	0	2.00	51.67	250.00

Any of the formats could be used in this case.

50,000 x 10 scale				
IND560 Displays:	0	200	5160	50000
Format sent:				
Integer	0	200	5160	-(15536)
Division	0	20	516	5000
Floating Point	0	200	5160	50000

The integer format could not be used because it would send a negative or invalid value once the weight exceeded 32,767.

150 x .001 scale				
IND560 Displays:	0	2.100	51.607	150.000
Format sent:				
Integer	0	2100	-13929	18928
Division	0	2100	-13929	18928
Floating Point	0	2.100	51.607	150.000

The integer and division formats could not be used because they would send a negative value once the weight exceeded 32,767.

2.2.3.

Byte Order

The byte order parameter sets the order in which the data bytes and words will be presented in the PLC data format. Available byte orders are:

- Word Swap – (default) Makes the data format compatible with RSLogix 5000 processors.
- Byte Swap - Makes the data format compatible with S7 PROFIBUS.
- Standard – Makes the data format compatible with PLC 5.
- Double Word Swap - Makes the data format compatible with the Modicon Quantum PLC for Modbus TCP networks.

Table 2-1 provides examples of the various byte ordering.

- Note: Byte Order was introduced into the IND560 in firmware version 3.xx. Terminals running firmware versions earlier than v3.xx will not see a setting for Byte Order in their setup selections.

Table 2-1: PLC Data Byte Ordering

		Word Swap			Byte Swap			Double Word Swap			Standard		
Terminal Weight Value		1355											
PLC		15	Bit #	0	15	Bit #	0	15	Bit #	0	15	Bit #	0
Integer	Weight value word	0x054B Hex			0x4B05 Hex			0x4B05 Hex			0x054B Hex		
Floating Point	1 st Weight value word	0x6000 Hex			0xA944 Hex			0x0060 Hex			0x44A9 Hex		
	2 nd Weight value word	0x44A9 Hex			0x0060 Hex			0xA944 Hex			0x6000 Hex		

2.2.4. Message Slots

The integer and division formats provide one-quarter rack (two 16-bit words of input and two 16-bit words of output data) per Message Slot. Depending upon the starting quarter there may be up to four Message Slots provided. Each Message Slot's first input word provides scale weight data and the input weight data may be selected by the PLC using the Message Slot's second output word bit 0, bit 1, and bit 2. Only the first Message Slot (second 16-bit output word) can be used to issue scale commands, download Target and Tare values, and turn outputs on and off. Table 2-2, Table 2-3, Table 2-1 and Table 2-5 provide input and output words and word usage information for Integer and Division modes with and without block transfer enabled.

The number of Message Slots is configured in Setup at **Communication > PLC > Data Format** (see Figure 2-3).

Table 2-2: PLC Input Words - Word Usage (Integer and Divisions), Block Transfer Disabled

PLC Input Words	Word Usage Start Quarter 1 (Group 0)	Word Usage Start Quarter 2 (Group 2)	Word Usage Start Quarter 3 (Group 4)	Word Usage Start Quarter 4 (Group 6)
0	Message Slot 1 Weight Data	-	-	-
1	Message Slot 1 Scale Status	-	-	-
2	Message Slot 2 Weight Data	Message Slot 1 Weight Data	-	-
3	Message Slot 2 Scale Status	Message Slot 1 Scale Status	-	-
4	Message Slot 3 Weight Data	Message Slot 2 Weight Data	Message Slot 1 Weight Data	-
5	Message Slot 3 Scale Status	Message Slot 2 Scale Status	Message Slot 1 Scale Status	-
6	Message Slot 4 Weight Data	Message Slot 3 Weight Data	Message Slot 2 Weight Data	Message Slot 1 Weight Data

PLC Input Words	Word Usage Start Quarter 1 (Group 0)	Word Usage Start Quarter 2 (Group 2)	Word Usage Start Quarter 3 (Group 4)	Word Usage Start Quarter 4 (Group 6)
7	Message Slot 4 Scale Status	Message Slot 3 Scale Status	Message Slot 2 Scale Status	Message Slot 1 Scale Status

Table 2-3: PLC Output Words - Word Usage (Integer and Division), Block Transfer Disabled

PLC Output Words	Word Usage Start Quarter 1 (Group 0)	Word Usage Start Quarter 2 (Group 2)	Word Usage Start Quarter 3 (Group 4)	Word Usage Start Quarter 4 (Group 6)
0	Message Slot 1 Weight Data	-	-	-
1	Message Slot 1 Scale Command	-	-	-
2	Message Slot 2 Weight Data	Message Slot 1 Weight Data	-	-
3	Message Slot 2 Scale Command	Message Slot 1 Scale Command	-	-
4	Message Slot 3 Weight Data	Message Slot 2 Weight Data	Message Slot 1 Weight Data	-
5	Message Slot 3 Scale Command	Message Slot 2 Scale Command	Message Slot 1 Scale Command	-
6	Message Slot 4 Weight Data	Message Slot 3 Weight Data	Message Slot 2 Weight Data	Message Slot 1 Weight Data
7	Message Slot 4 Scale Command	Message Slot 3 Scale Command	Message Slot 2 Scale Command	Message Slot 1 Scale Command

Table 2-4: PLC Input Words - Word Usage (Integer and Division), Block Transfer Enabled

PLC Input Words	Word Usage Start Quarter 1 (Group 0)	Word Usage Start Quarter 2 (Group 2)	Word Usage Start Quarter 3 (Group 4)	Word Usage Start Quarter 4 (Group 6)
0	Not Valid	Reserved	Reserved	Reserved
1	Not Valid	Reserved	Reserved	Reserved
2	Not Valid	Message Slot 1 Weight Data	-	-
3	Not Valid	Message Slot 1 Scale Status	-	-
4	Not Valid	Message Slot 2 Weight Data	Message Slot 1 Weight Data	-
5	Not Valid	Message Slot 2 Scale Status	Message Slot 1 Scale Status	-
6	Not Valid	Message Slot 3 Weight Data	Message Slot 2 Weight Data	Message Slot 1 Weight Data
7	Not Valid	Message Slot 3 Scale Status	Message Slot 2 Scale Status	Message Slot 1 Scale Status

Table 2-5: PLC Output Words - Word Usage (Integer and Division), Block Transfer Enabled

PLC Output Words	Word Usage Start Quarter 1 (Group 0)	Word Usage Start Quarter 2 (Group 2)	Word Usage Start Quarter 3 (Group 4)	Word Usage Start Quarter 4 (Group 6)
0	Not Valid	Reserved	Reserved	Reserved
1	Not Valid	Reserved	Reserved	Reserved
2	Not Valid	Message Slot 1 Weight Data	-	-
3	Not Valid	Message Slot 1 Scale Command	-	-
4	Not Valid	Message Slot 2 Weight Data	Message Slot 1 Weight Data	-
5	Not Valid	Message Slot 2 Scale Command	Message Slot 1 Scale Command	-
6	Not Valid	Message Slot 3 Weight Data	Message Slot 2 Weight Data	Message Slot 1 Weight Data
7	Not Valid	Message Slot 3 Scale Command	Message Slot 2 Scale Command	Message Slot 1 Scale Command

The floating point format provides one-half rack (four 16-bit words of input and up to four 16-bit words of output data) per Message Slot. See Table 2-6 and Table 2-7 for details.

The number of Message Slots is configured in Setup at **Communication > PLC > Data Format** (see Figure 2-3).

Table 2-6: PLC Floating Point Input Words

PLC Output Words	Bits 0 - 7	Bits 8 - 15
0	Message Slot 1: Reserved	Message Slot 1: Command Response
1	Message Slot 1: Floating Point data	Message Slot 1: Floating Point data
2	Message Slot 1: Floating Point data	Message Slot 1: Floating Point data
3	Message Slot 1: Scale Status	Message Slot 1: Scale Status
4	Message Slot 2: Reserved	Message Slot 2: Command Response
5	Message Slot 2: Floating Point data	Message Slot 2: Floating Point data
6	Message Slot 2: Floating Point data	Message Slot 2: Floating Point data
7	Message Slot 2: Scale Status	Message Slot 2: Scale Status

Table 2-7: PLC Floating Point Output Words

PLC Output Words	Usage
0	Reserved
1	Message Slot 1: Command
2	Message Slot 1: Floating Point data

PLC Output Words	Usage
3	Message Slot 1: Floating Point data
4	Message Slot 2: Command
5	Message Slot 2: Floating Point data
6	Message Slot 2: Floating Point data
7	Not Used

- The data layout of the Message Slots is defined in Appendix A (Integer and Division) and Appendix B (Floating Point).

2.2.5. Integer and Division

When integer or division selected, the IND560 will have one quarter rack of data in each Message Slot (two 16-bit words for input data and two 16-bit words for output data). The PLC's input data will contain one 16-bit word for the scale's weight information and one 16-bit word for bit encoded status information for each Message Slot. The IND560 will send specific weight data to the PLC input data based on the data it receives from the PLC's output data. The PLC's output words consist of one 16-bit integer value, which may be used to download a tare or target, and one 16-bit word for bit encoded command information.

Appendix A provides detailed information on the integer and division data formats.

2.2.6. Floating Point

2.2.6.1. Operational Overview

The IND560 uses integer commands from the PLC to select the floating point weight output data. The IND560 recognizes a command when it sees a new value in the Message Slot command word. If the command has an associated floating point value (for example: loading a target value), it must be loaded into the floating point value words before the command is issued. Once the IND560 recognizes a command, it acknowledges the command by setting a new value in the command acknowledge bits of the scale's command response word. The IND560 also tells the PLC what floating point value is being sent (via the floating point input indicator bits of the command response word). The PLC should wait until it receives the command acknowledgment from the IND560 before sending another command.

The IND560 has two types of values that it can report to the PLC: real-time and static. When the PLC requests a real-time value, the IND560 acknowledges the command from the PLC once but sends and updates the value at every A/D update. If the PLC requests a static value, the IND560 acknowledges the command from the PLC once and updates the value once. The IND560 will continue to send this value until it receives a new command from the PLC. Gross weight and net weight are examples of real-time data. Tare weight, target, feed, and tolerance values are examples of static data.

The IND560 can send a rotation of up to nine different real-time values. The PLC sends commands to the IND560 to add a value to the rotation. Once the rotation is established, the PLC must instruct the IND560 to begin its rotation automatically, or the PLC may control the pace of rotation by instructing the IND560 to advance to the next value. If the IND560 is asked to automatically alternate its output data, it will switch to the next value in its rotation at the next A/D update. (The

A/D update rate depends on the scale type. An analog scale has an update rate of 20 Hz or 58 milliseconds.)

The PLC may control the rotation by sending alternate report next field commands (1 and 2). When the PLC changes to the next command, the IND560 switches to the next value in the rotation. The IND560 stores the rotation in its shared data so the rotation does not have to be re-initialized after each power cycle. When the PLC does not set up an input rotation, the default input rotation consists of gross weight only. Refer to the floating-point command examples in Appendix B for additional information.

The method of handling string and floating point data varies between Allen-Bradley PLC generations. The IND560 provides floating point data in the order used by the PLC5. The ControlLogix 5000 is the reverse of the PLC5 and requires programming steps to perform word swapping of the 32-bit floating point data received.

Appendix B provides detailed information of the floating point data format.

2.2.6.2. Floating Point Data Format and Compatibility

■ Appendix A provides detailed information of the floating point data format.

In Floating Point Message mode, the PLC and terminal exchange weight, target, and tare data in single-precision floating-point format. The IEEE Standard for Binary Floating-Point Arithmetic, ANSI/IEEE Standard 754-1985, specifies the format for single-precision floating point numbers. It is a 32-bit number that has a 1-bit sign, an 8-bit signed exponent, and a 23-bit mantissa. The 8-bit signed exponent provides scaling of weight data. The 23-bit mantissa allows representation of 8 million unique counts.

Although the single-precision floating point number provides greater numerical precision and flexibility than integer weight representations, it has limitations. The weight representation may not be exact, particularly for the extended-resolution weight fields for high-precision bases.

Some Allen-Bradley PLCs require special integrity checking to communicate floating point numbers across the Remote I/O link. The Allen-Bradley PLC-5 and KTX Scanner Card programs must check two data integrity bits to verify the integrity of the floating point data it reads from the terminal. Allen-Bradley SLC programs always read valid floating-point data from the terminal and do not have to make special checks to guarantee the validity of the floating-point data. The Allen-Bradley PLC-3 and PLC-5/250 cannot support terminals in floating point mode as they cannot guarantee the integrity of the floating-point data.

There are two data integrity bits that the terminal uses to maintain data integrity when communicating with the Allen-Bradley PLC-5 Remote I/O Scanner or KTX Scanner Card. One bit is in the beginning byte of the data; the second is in the ending byte of the data for a scale slot. The PLC program must verify that both data integrity bits have the same polarity for the data in the scale slot to be valid. There is a possibility that the PLC program will see several consecutive invalid reads when the terminal is freely sending weigh updates to the PLC-5 program detects this condition, it should send a new command to the terminal.

The Allen-Bradley SLC PLC programs do not have to make special checks to guarantee the validity of the floating-point data.

The method of handling string and floating point data varies between Allen-Bradley PLC generations. The IND560 provides floating point data in the order used by the PLC5. The ControlLogix 5000 is the reverse of the PLC5 and requires programming steps to perform word swapping of the 32-bit floating point data received.

2.2.6.3. Shared Data Mode

The Shared Data mode PLC communication is not available with the A-B RIO option. Block Transfer communication is used instead.

2.2.7. Block Transfer

Block Transfer mode is much less efficient than the discrete data modes, which are optimized for real time communications of weight and status data. Block Transfer mode accesses the IND560 "Shared Data" directory structure each time a data item is accessed. By contrast, the discrete mode communications has a direct interface to a limited number of real time terminal data fields.

- Do not use Block Transfer mode for real-time communications.

2.2.7.1. Block Transfer Data

Block transfer allows the IND560 terminal and PLC to exchange many types of data in blocks of up to 88 bytes.

Block transfer works concurrently with discrete data. Discrete mode communicates continuously in the background and a block transfer occurs only when the PLC program executes a block transfer read or write instruction. Data transfer is controlled by the PLC.

2.2.8. Block Transfer Formats

Table 2-8 and Table 2-9 provide block transfer format information for block transfer write to the terminal and block transfer read from the terminal.

Table 2-8: Block Transfer Write (Words 0–62) to Terminal

Base #	0	1	2	3	4	5	6	7	8	9
N#:0	Display Mode*	16 Byte Display String: sent from PLC to terminal shared data if preceding word is non-zero value and discrete display bits are set to 7								8 Byte>> ASCII
N#:10	<<Floating Point Write Field Code: shows where next value will be loaded		Floating Point Write Value		8 Byte ASCII String Write Field Code: shows where the next value will be loaded				40 Byte>>	
N#:20	<<40 Byte String Data. Note: if string is shorter than 40 bytes it must be left justified and null-terminated >>									
N#:30	<< 40 Byte String Data. Note: if string is shorter than 40 bytes it must be left-justified (and null-terminated)>>								8 Byte>> ASCII	
N#:40	<<Floating Point Read Field Code: requests FP value for BTR		8 Byte (ASCII) String Read Field Code: requests string value for BTR			Reserved				

N#:50	Reserved						
N#:60	Reserved						

Table 2-9: Block Transfer Read (Words 0–62) from Terminal

Base #	0	1	2	3	4	5	6	7	8	9
N#:0	8 Byte (ASCII) Floating Point Read Field Code: name of value sent in next field			Floating Point Read Value		8 Byte (ASCII) String Read Field Code: name of string sent in next field				
N#:10	40 Byte Data String>>									
N#:20	<<40 Byte String Data. Note: if string is shorter than 40 bytes it must be left-justified (and null-terminated)>>									
N#:30	Reserved									
N#:40	Reserved									
N#:50	Reserved									
N#:60	Reserved									

* Display Mode: The integer value of this word determines how the IND560 display operates:

- 0 = reset display to normal mode
- 1 = display until overwritten by PLC or ENTER is pressed
- 2 = display for 30 seconds
- 3 = display for 60 seconds, any value
- > 3 = reserved.

All Field Codes are six right-justified bytes expanded to eight with two leading spaces.

Example Shared Data = wf0101 . Hex value of field code = 2020 7774 3031 3031

2.2.8.1. Floating Point and String Data Field Codes for BTW/BTR

Table 2-10 and Table 2-11 describe some of the floating point and string data fields that the IND560 terminal can access. String data fields are ASCII character strings that identify an IND560 Shared Data variable. Each table contains the following information:

- Field Code – is the ASCII field that must be loaded into the Block Transfer write buffer. It identifies the data that is written to the terminal or returned by the terminal in a Block Transfer read.

The field code must be expanded to eight ASCII bytes by filling with two leading spaces. The field code structure is CCIIAA; where CC is the Shared Data Class consisting of two ASCII alpha characters; where II is the Shared Data Class Instance consisting of two ASCII numeric characters; where AA is the Shared Data Class Instance Attribute consisting of two ASCII numeric characters. The Shared Data Class Instance is typically '01', there are only a few Shared Data Classes that have more than one Instance.

Block Transfer Shared Data Variables are either an ASCII string or a number. Numbers are written and read as a 32-bit floating point value. If the Shared Data Variable is not a string then it is a number.

- Description – is a description of the field.
- Read/Write – indicates whether the PLC can read and/or write to the field.

- Length – is the number of bytes (length) of the field. All floating point values are 4 bytes (2 words) long. Strings are the length specified.

Table 2-10: Floating Point Accessible Shared Data Fields

Field Code	Description	Read/Write	Length
wt0110	Gross Weight	R	4
wt0111	Net Weight	R	4
wt0112	Auxiliary Gross Weight	R	4
wt0113	Auxiliary Net Weight	R	4
ws0102	Tare Weight	R	4
ws0104	Auxiliary Tare Weight	R	4
sp0105	Target Coincidence Value	R/W	4
wx0131	Scale Motion (0 or 1)	R	4
wx0132	Center of Zero (0 or 1)	R	4
wx0133	Over Capacity (0 or 1)	R	4
wx0134	Under Zero (0 or 1)	R	4
wx0135	Net Mode (0 or 1)	R	4
ws0101	Current Scale Mode	R	4
ws0102	Tare Weight	R	4
ws0104	Auxiliary Tare Weight	R	4
ws0105	Current Units	R	4
ws0106	Tare Source	R	4
cs0104	Auxiliary Weight Units	R/W	4
sp0104	Target Data Stream Type	R/W	4
xp0101	Transaction Counter	R/W	4

Table 2-11: Accessible String Shared Data Fields

Field Code	Description	Read/Write	Length
wt0101	Gross Weight	R	13
wt0102	Net Weight	R	13
wt0103	Weight Units	R	4
wt0104	Auxiliary Gross Weight	R	13
wt0105	Auxiliary Net Weight	R	13
wt0106	Auxiliary Weight Units	R	7
cs0112	Custom Units Name	R/W	13
cs0103	Scale ID	R/W	21
Cs0113	Custom Unit Conversion Factor		

Field Code	Description	Read/Write	Length
sp0101	Target Description	R/W	21
xd0103	Current Date	R	12
xd0104	Time of Day	R	12
xs0104	Software Part Number	R	15
pr0131	ID1 Prompt	R/W	40
pr0132	ID2 Prompt	R/W	40
pa0101	ID1 Response	R/W	40
pa0102	ID2 Response	R/W	40
pt0101	Print Template 1	R/W	40
pt0111	Print Literal 1	R/W	40

Refer to the IND560 Shared Data Reference manual for a full list of Shared Data variables. The Shared Data reference can be found on IND560 documentation CD, part number 71209397.

2.2.9. Controlling the Discrete I/O Using a PLC Interface

The IND560 terminal provides the ability to directly control its discrete outputs and read its discrete inputs via the (digital) PLC interface options. System integrators should be aware that the terminal's discrete I/O updates are synchronized with the terminal's A/D rate and not with the PLC I/O scan rate. This may cause a noticeable delay in reading inputs or updating outputs as observed from the PLC to real world signals. Consult the IND560 Terminal Technical Manual for discrete I/O wiring. Also note the outputs must be unassigned in the IND560 terminal setup.

2.3. Hardware Setup

2.3.1. Wiring

The IND560 terminal's A-B RIO option card uses a three-position removable terminal strip to connect to the A-B RIO network interface (Figure 2-2). Cable distance, type, and termination are specified by Allen-Bradley (Refer to Allen-Bradley documentation for reference on cable design guidelines for the various PLCs). METTLER TOLEDO recommends Belden 9463 cable.

- The terminal strip connector comes with the A-B RIO interface option kit.

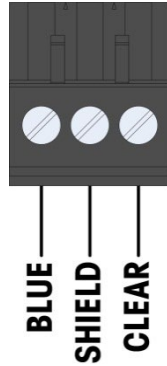
**NOTES:**

1. CONNECTION WITH TWIN AXIAL CABLE (BLUE HOSE) SHOWN.
2. REFER TO ALLEN-BRADLEY REMOTE I/O DOCUMENTATION FOR TERMINATION RESISTOR AND OTHER CONSIDERATIONS.
3. WIRE SIZE: 14 AWG (2.088 mm²) MAXIMUM
22 AWG (0.322 mm²) MINIMUM.

Figure 2-2: Three-Position Terminal Strip Wiring

2.4. Software Setup

The IND560 terminal automatically detects the presence of an A-B RIO Kit option board if one is installed. When detected, the IND560 terminal adds the Allen-Bradley parameters in a program block under Communication > PLC.

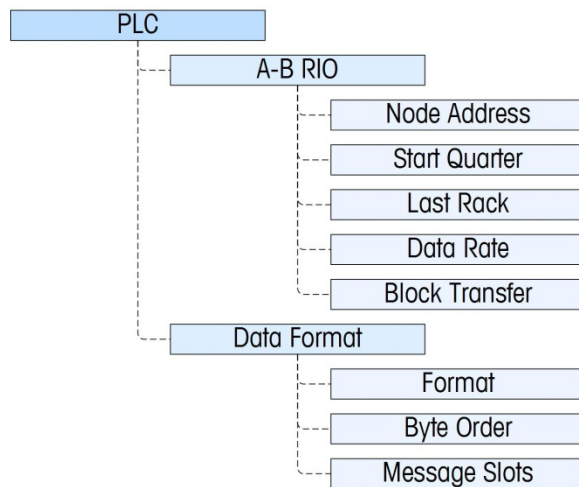

Figure 2-3: A-B RIO Program Block

2.4.1. A-B RIO Setup Sub-Block

2.4.1.1. A-B RIO setup

In Setup, access Communication > PLC > A-B RIO.

2.4.1.1.1. Node Address

Prior to the Node Address text box is a selection field allowing the user to enter the node address in either Decimal or Octal.

Then select the Node Address text box and using the numeric keypad to enter the appropriate node address (0–62).

- 2.4.1.1.2. Start Quarter (Group)
Use the selection box to select the appropriate start quarter address 1–4 (group 0–6).
- 2.4.1.1.3. Last Rack
Select Disabled or Enabled for last rack designation.
- 2.4.1.1.4. Data Rate
Use the selection box to select the desired data rate. Selections available are 56.6 Kb, 115.2 Kb or 230.4 Kb.
- 2.4.1.1.5. Block Transfer
Use the Block Transfer selection box to either Disable or Enable the block transfer mode of operation.
- 2.4.1.2. Data Format setup
In Setup, access Communication > PLC > Data Format.
- 2.4.1.2.1. Format
The data format is selected from a drop-down list. Choose Divisions, Integer (default) or Floating Point.
- 2.4.1.2.2. Byte Order
Available selections are Standard, Byte Swap, Word Swap (default), and Double Word Swap. See Table 2-1 for definitions.
- 2.4.1.2.3. Message Slots
Select from 1 to 4 message slots.

2.5. Troubleshooting

If the IND560 does not communicate with PLC do the following:

- Check wiring and network termination.
- Confirm that the IND560 settings for data type and rack assignment match those in the PLC.
- Replace the A-B RIO interface kit if the problem persists.
- If the communication kit was changed from another type, like PROFIBUS, ControlNet or EtherNet I/P, carry out a Master Reset on the IND560.

2.5.1. Status LEDs

The A-B RIO card has an LED indicator to indicate communication status of the card. Figure 2-4 indicates the location of the LED, and Table 2-12 explains its indications.

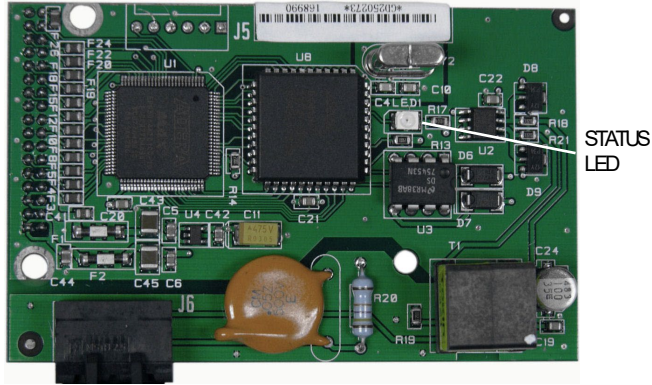

Figure 2-4: A-B RIO Card Status LED

Table 2-12: A-B RIO Status LED Indications

LED Indications	Meaning
No LED	Bad card or no power. Check cable wiring or PLC power.
Solid Green	Online and communicating
Blinking LED	Power to network but node not communicating to PLC. Check for rack size or data size mismatch.

2.6. Allen-Bradley RIO Interface Kit Part Numbers

- The Allen-Bradley RIO interface was discontinued in January 2021. Information provided in this manual is for the purpose of legacy installation support only.

There are no associated spare parts with the A-B RIO option kit. The option kit part number is 71209098. Table 2-13 shows what is included in the kit.

Table 2-13: A-B RIO Option Kit

Description	Qty.
Installation Instructions	1
PCB Package	1
Installation Kit	1
Gland Kit	1

2.7. Interfacing Examples

The remaining Figures show sample screens from ladder logic programming examples for RSLogix 5000 software. The documentation CD part number 71209397 contains complete versions of these.

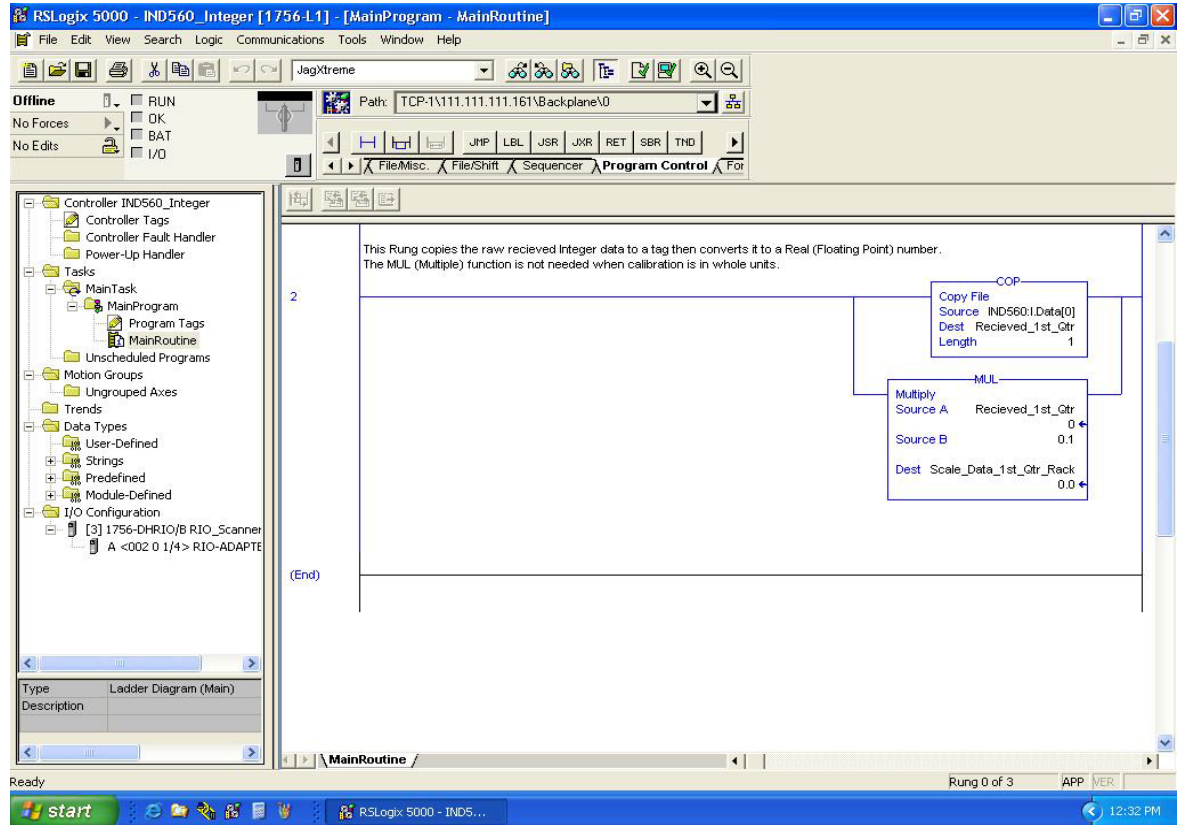

Figure 2-5: RSLogix 5000 – IND560 Integer

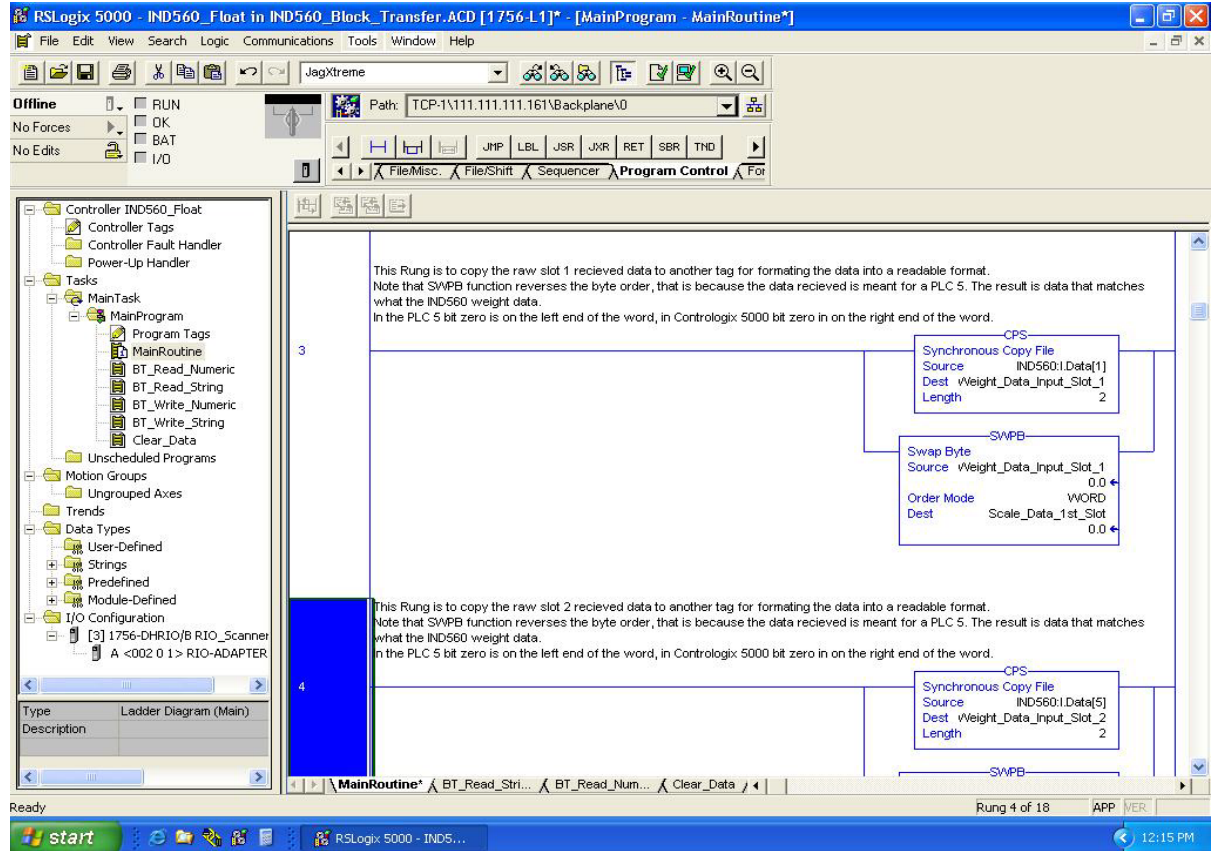

Figure 2-6: RSLogix 5000 – IND560 Integer

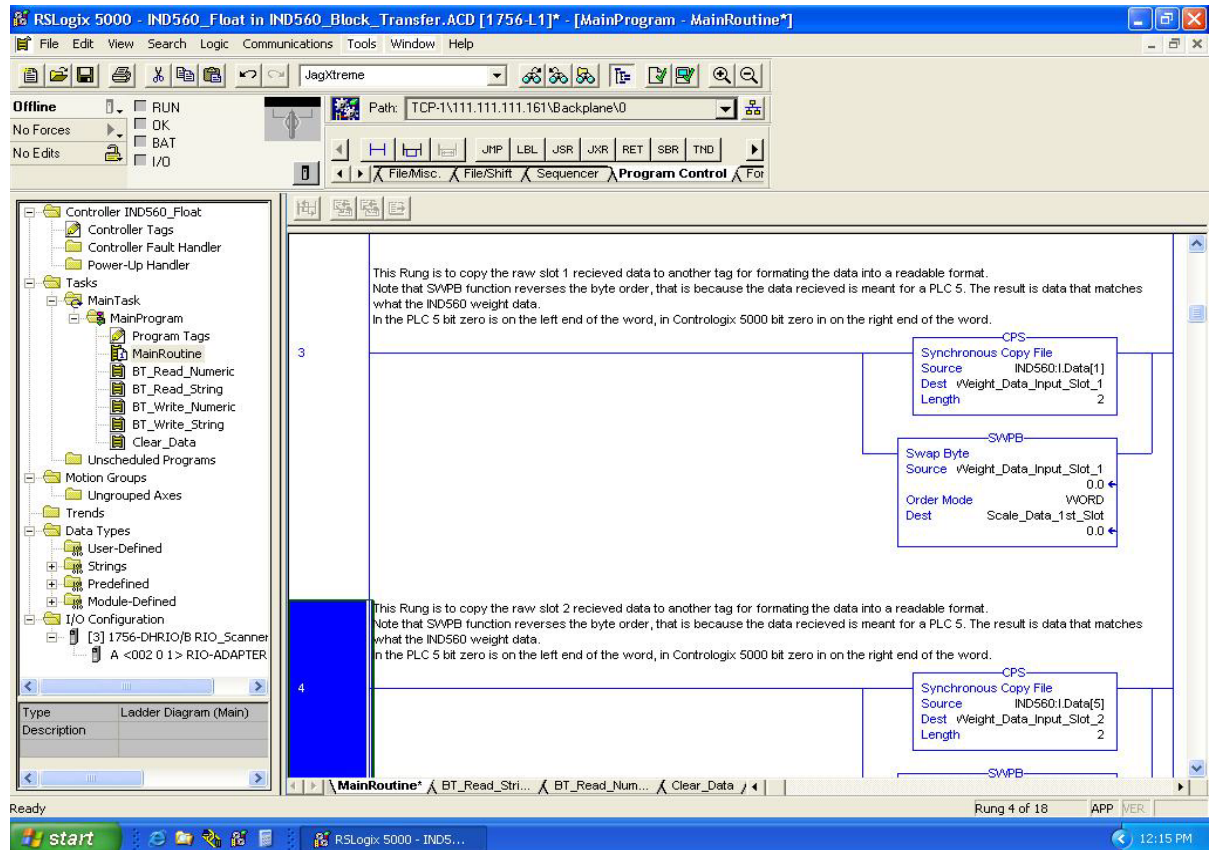

Figure 2-7: RSLogix 5000–IND560 Float in IND560 Block Transfer (slot 1)

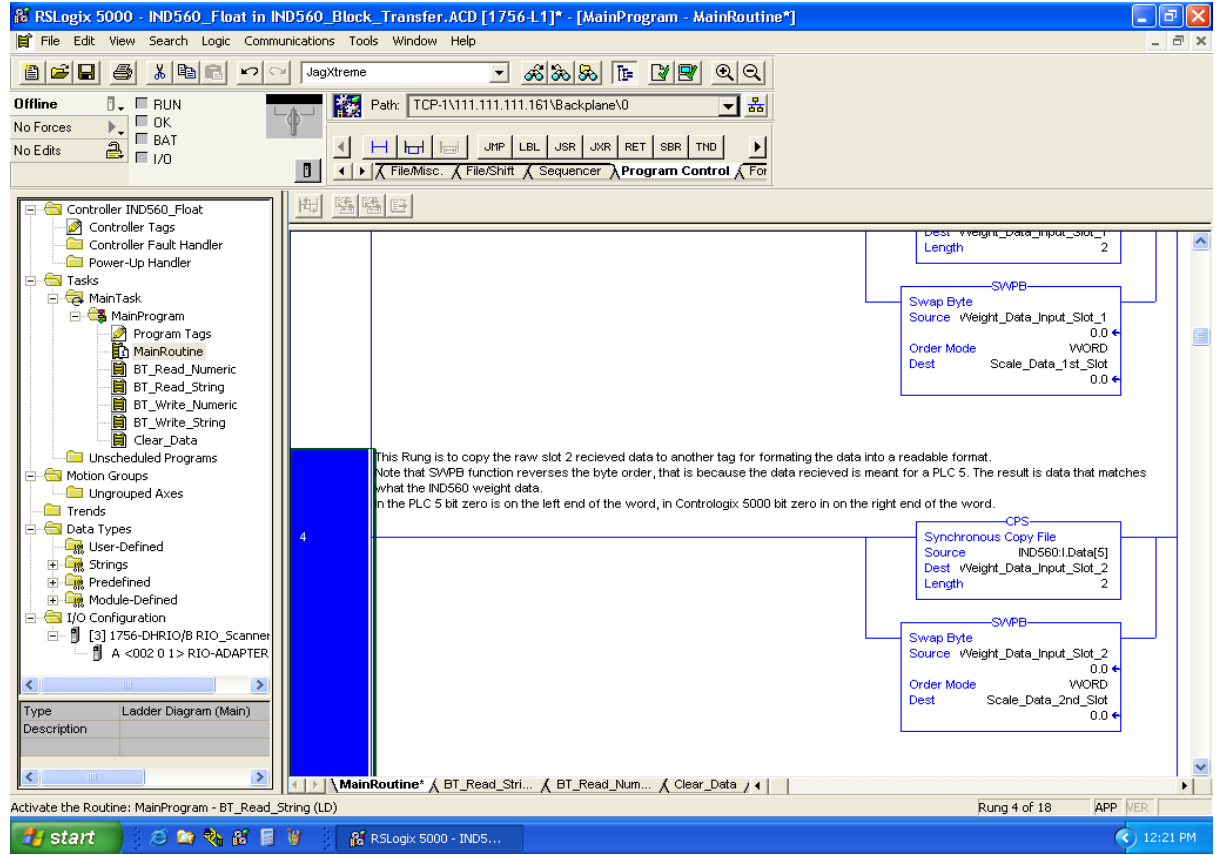

Figure 2-8: RSLogix 5000 – IND560 Float in IND560 Block Transfer (slot 2)

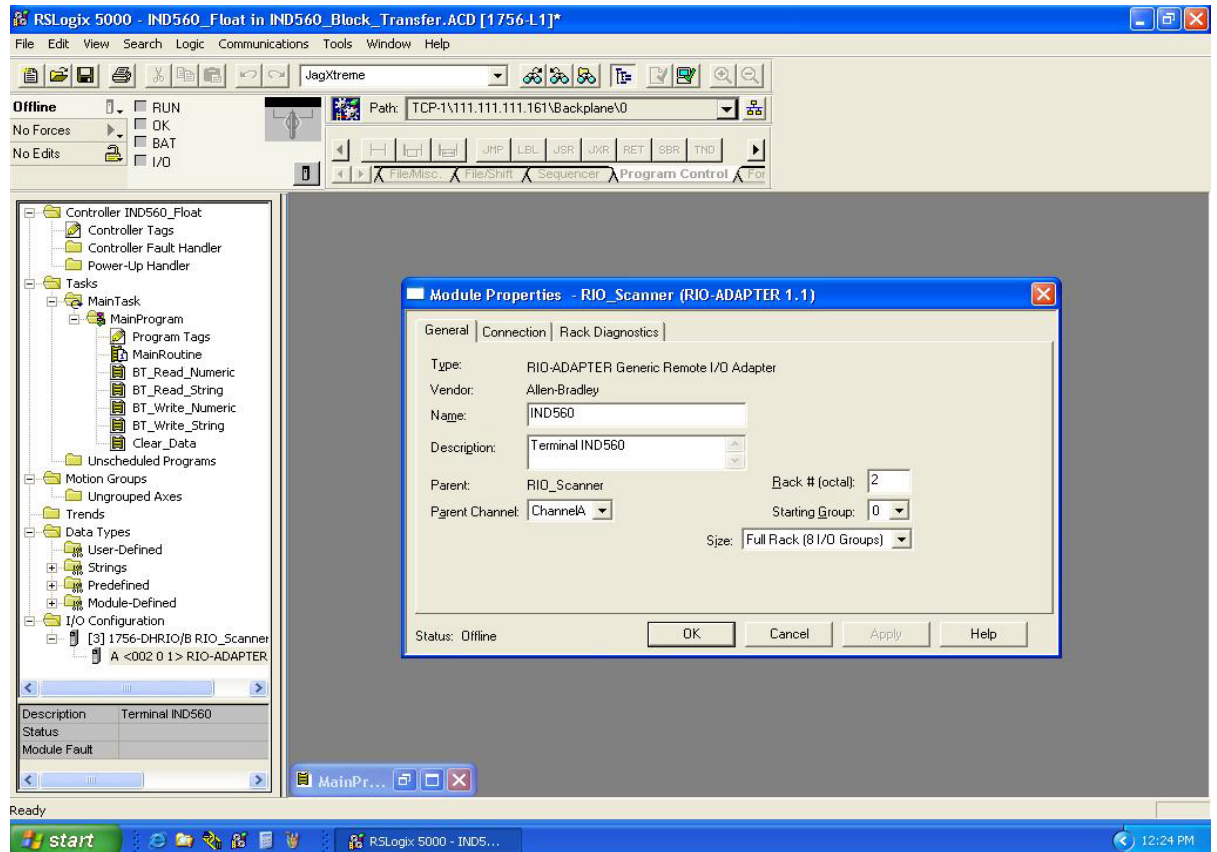

Figure 2-9: RSLogix 5000 Scanner Configuration (screen 1)

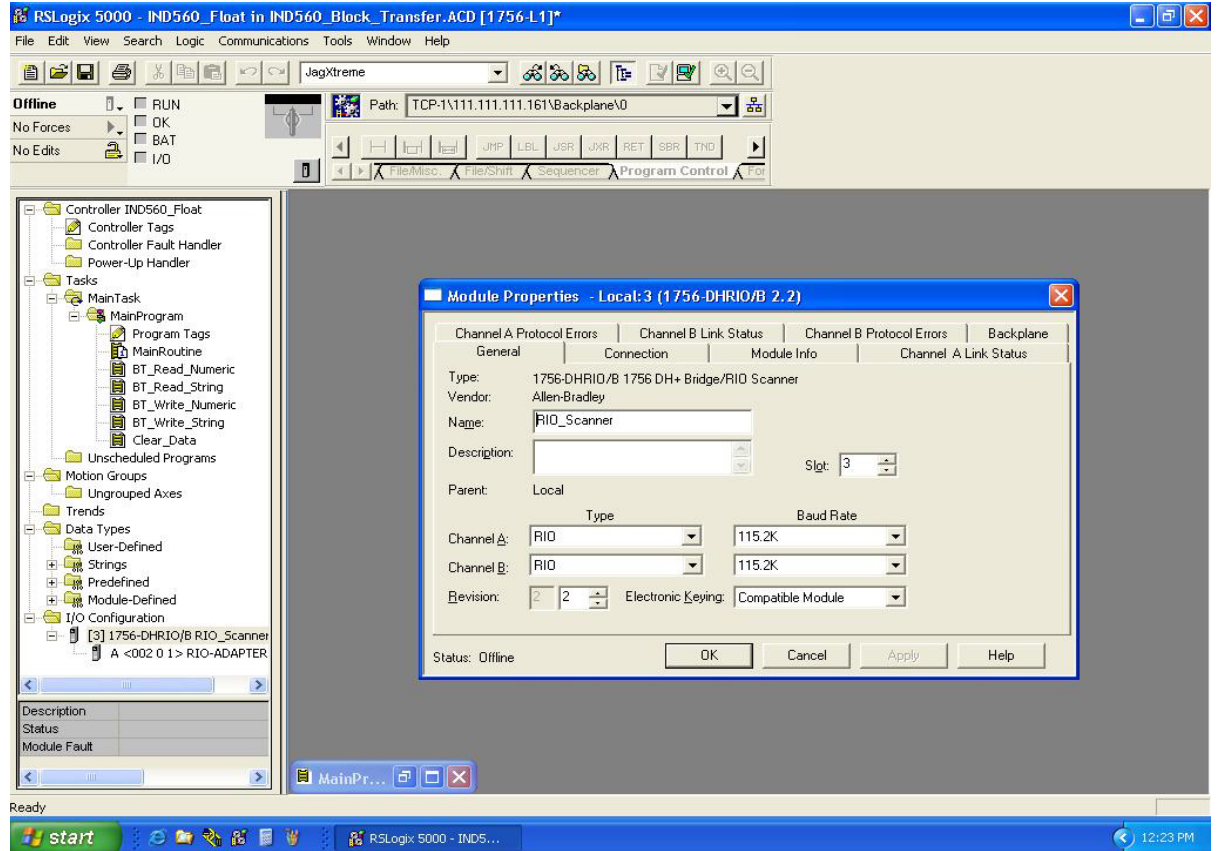

Figure 2-10: RSLogix 5000 Scanner Configuration (screen 2)

3 DeviceNet™ Option

- The DeviceNet interface in the ACM500 was discontinued in December 2022. The DeviceNet information in this manual is provided to support legacy installations only.

3.1. Preface

Users should note that the DeviceNet option is used in both the Mettler Toledo IND560 and IND780 terminals. There are minor differences in the Floating Point polled data between the two terminals. Both terminals share the same EDS file and Icon file for use in a DeviceNet network configuration tool.

This chapter describes connections and setup that are specific to the DeviceNet option. The formats of the data that is transferred between the indicator and the PLC are described in Appendix A and Appendix B.

3.2. Overview

DeviceNet is an RS-485 based network utilizing CAN chip technology. This network was created for bit and byte-level devices. The network can be configured to run up to 500Kbits per second depending on cabling and distances. Messages are limited to 8 un-fragmented bytes. Any larger message must be broken up and sent in multiples. The IND560 implementation of DeviceNet does not support fragmented messages - all messages are 8 bytes or shorter. The network is capable of 64 nodes including the master, commonly called the scanner.

3.3. DeviceNet Characteristics

- DeviceNet specific cable (twisted pair)
- Access to intelligence present in low-level devices – Master/Slave and Peer-to-Peer capabilities
- Trunkline-dropline configuration
- Support for up to 64 nodes
- Node removal without severing the network
- Simultaneous support for both network-powered (sensors) and self-powered (actuators) devices
- Use of sealed or open style connectors

- Protection from wiring errors
- Selectable baud rates of 125k baud, 250k baud, and 500k baud. Maximum trunk distance 500 meters and drop length of 156 meters at 125k baud
- Adjustable power configuration to meet individual application needs
- High current capability (up to 8 amps per supply)
- Operation with off-the-shelf power supplies
- Power taps that allow the connection of several power supplies from multiple vendors that comply with DeviceNet standards
- Built-in overload protection
- Power available along the bus: both signal and power lines contained in the trunkline
- Provisions for the typical request/response-oriented network communications
- Provisions for the efficient movement of I/O data
- Fragmentation (anything in excess of 8 bytes) for moving larger bodies of information
Note: Mettler Toledo Terminals do not support fragmented messaging.
- Duplicate MAC ID detection

Consult <http://www.odva.org/> to obtain additional information on DeviceNet.

Figure 3-1 shows a view of the DeviceNet Option Board, with its connector at lower left. Figure 3-2 indicates the board's connector and status lights.

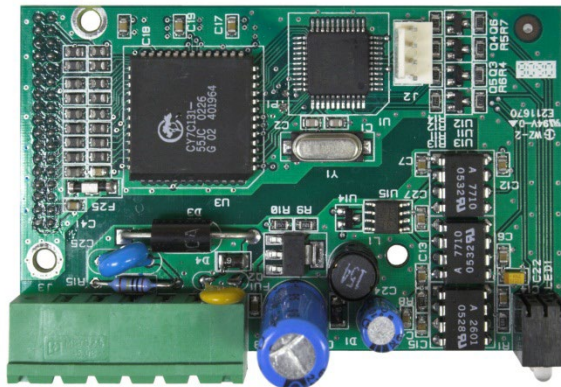

Figure 3-1: DeviceNet Option Board



Figure 3-2: DeviceNet Option Board Components

3.3.1. Communications

The IND560 utilizes polled messages. This type of message may be referred to as scheduled or cyclic messages. It does not support explicit or unscheduled messaging.

3.3.2. Node Address

The IND560 can be assigned any valid DeviceNet node address. Typically 0 is reserved for scanner cards and address 63 is reserved for new devices “out of the box”.

3.3.3. Data Formats

While being polled, the IND560 supports floating point, integer, or divisions.

- **Integer** – Reports scale weight as a signed 16 bit integer.
- **Divisions** – Reports scale weight in display divisions. The PLC multiplies the reported divisions by the increment size to calculate the weight in display units.
- **Floating Point** – Displays weight in floating point data format.

Shared Data access isn't available using DeviceNet. Appendix A and B provide detailed information on data formats.

3.3.4. Network Power and Current

Table 3-1 and Table 3-2 detail power and current characteristics of the DeviceNet network.

Table 3-1: Network Power Consumption

Voltage	Current
11 V	50 mA
25 V	30 mA

Table 3-2: Network Inrush Current

Voltage	Current	Duration
24 V	0.7 A	6 ms

3.4. Data Definition

3.4.1. Data Integrity

The IND560 Terminals have specific bits to allow the PLC to confirm that data was received without interrupt and the IND560 Terminal is not in an error condition. It is important to monitor these bits. Any PLC code should use them to confirm the integrity of the data received for the IND560 Terminal. Refer to the data charts for specific information regarding the Data OK, Update in Progress, Data Integrity bits and their usage.

3.4.2. Data Formats

There are three formats of discrete data available with the DeviceNet interface option: integer, division, and floating point. Only one type of data format may be selected and used by IND560 Terminals sharing the same DeviceNet logical node address.

The integer and division formats allow bi-directional communication of discrete bit encoded information or 16 bit binary word numerical values. The IND560 terminal provides four bytes per message slot. Two slots are available in integer and division mode while only one eight byte slot is available via floating point mode.

The floating-point format allows bi-directional communication of discrete bit encoded information or numeric data encoded in IEEE 754, single precision floating point format. The floating-point format requires more space per IND560 terminal because floating point data uses two 16-bit words of data to represent just the numeric data alone. Selection of the appropriate format depends on issues such as the range or capacity of the scale used in the application. The integer format can represent a numerical value up to 32,767. The division format can represent a value up to 32,767 scale divisions or increments. The floating-point format can represent a value encoded in IEEE 754, single precision floating point format.

3.4.2.1. Examples

250 x .01 scale				
IND560 Displays:	0	2.00	51.67	250.00
Format sent:				
Integer	0	200	5167	25000
Division	0	200	5167	25000
Floating Point	0	2.00	51.67	250.00

■ Any of the formats could be used in this case.

50,000 x 10 scale				
IND560 Displays:	0	200	5160	50000
Format sent:				
Integer	0	200	5160	-(15536)
Division	0	20	516	5000
Floating Point	0	200	5160	50000

The integer format could not be used because it would send a negative or invalid value once the weight exceeded 32,767.

150 x .001 scale				
IND560 Displays:	0	2.100	51.607	150.000
Format sent:				
Integer	0	2100	-13929	18928

150 x .001 scale				
Division	0	2100	-13929	18928
Floating Point	0	2.100	51.607	150.000

The integer and division formats could not be used because they would send a negative value once the weight exceeded 32.767.

3.4.3. Byte Order

The byte order parameter sets the order in which the data bytes and words will be presented in the PLC data format. Available byte orders are:

- Word Swap – (default) Makes the data format compatible with RSLogix 5000 processors.
- Byte Swap - Makes the data format compatible with S7 PROFIBUS.
- Standard – Makes the data format compatible with PLC 5.
- Double Word Swap - Makes the data format compatible with the Modicon Quantum PLC for Modbus TCP networks.

Table 3-3 provides examples of the various byte ordering.

- Note: Byte Order was introduced into the IND560 in firmware version 3.xx. Terminals running firmware versions earlier than v3.xx will not see a setting for Byte Order in their setup selections.

Table 3-3: PLC Data Byte Ordering

		Word Swap			Byte Swap			Double Word Swap			Standard		
Terminal Weight Value		1355											
PLC		15	Bit #	0	15	Bit #	0	15	Bit #	0	15	Bit #	0
Integer	Weight value word	0x054B Hex			0x4B05 Hex			0x4B05 Hex			0x054B Hex		
Floating Point	1 st Weight value word	0x6000 Hex			0xA944 Hex			0x0060 Hex			0x44A9 Hex		
	2 nd Weight value word	0x44A9 Hex			0x0060 Hex			0xA944 Hex			0x6000 Hex		

3.4.4. Message Slots

There may be up to 2 message slots for discrete data transfer in the integer or divisions data formats and one message slot for the Floating point data format. Each message slot represents the scale but may be controlled by the PLC to present different data in each message slot. The integer and division formats provide two 16-bit words of input and two 16-bit words of output data per slot. Each message slot's first input word provides scale weight data. The type of data displayed, such as gross, tare, etc., is selected by the PLC using the message slot's second output word bits 0, bit 1 and bit 2. Table 3-4 and Table 3-5 provide input and output usage information.

The data format for the slots are described in Appendix A and B.

Table 3-4: DeviceNet PLC Input Data - Data Usage (Integer and Division)

PLC Input Bytes	PLC Input Words	Usage
0	0	Message Slot 1 Weight Data
1		Message Slot 1 Weight Data
2	1	Message Slot 1 Scale Status
3		Message Slot 1 Scale Status
4	2	Message Slot 2 Weight Data
5		Message Slot 2 Weight Data
6	3	Message Slot 2 Scale Status
7		Message Slot 2 Scale Status

Table 3-5: DeviceNet PLC Output Words - Word Usage (Integer and Division)

PLC Output Bytes	PLC Output Words	Usage
0	0	Message Slot 1 Weight Data
1		Message Slot 1 Weight Data
2	1	Message Slot 1 Scale Command
3		Message Slot 1 Scale Command
4	2	Message Slot 2 Weight Data
5		Message Slot 2 Weight Data
6	3	Message Slot 2 Scale Command
7		Message Slot 2 Scale Command

The floating point format provides four 16-bit words of input data and four 16-bit words of output data. Details are provided in Table 3-6 and Table 3-7.

The format of the floating point data is shown in Appendix B.

Table 3-6: DeviceNet PLC Floating Point Input Words

PLC Input Words	Bits 0 – 7	Bits 8 – 15
0	Message Slot 1 Reserved	Message Slot 1 Command Response
1	Message Slot 1 Floating Point data	Message Slot 1 Floating Point data
2	Message Slot 1 Floating Point data	Message Slot 1 Floating Point data
3	Message Slot 1 Scale Status	Message Slot 1 Scale Status

Table 3-7: DeviceNet PLC Floating Point Output Words

PLC Output Bytes	PLC Output Words	Usage
0	0	Reserved
1		Reserved
2	1	Message Slot 1 Command
3		Message Slot 1 Command
4	2	Message Slot 1 Floating Point data
5		Message Slot 1 Floating Point data

PLC Output Bytes	PLC Output Words	Usage
6	3	Message Slot 1 Floating Point data
7		Message Slot 1 Floating Point data

3.5. Floating Point

3.5.1. Operational Overview

The terminal uses integer commands from the PLC to select the floating point weight output data. The terminal recognizes a command when it sees a new value in the scale's command word. If the command has an associated floating point value (for example: loading a target value), it must be loaded into the floating point value words before the command is issued. Once the terminal recognizes a command, it acknowledges the command by setting a new value in the command acknowledge bits of the scale's command response word. It also tells the PLC what floating point value is being sent (via the floating point input indicator bits of the command response word). The PLC waits until it receives the command acknowledgment from the terminal before sending another command.

The terminal has two types of values that it can report to the PLC: real-time and static. When the PLC requests a real-time value, the terminal acknowledges the command from the PLC once but sends and updates the value at every A/D update. If the PLC requests a static value, the terminal acknowledges the command from the PLC once and updates the value once. The terminal will continue to send this value until it receives a new command from the PLC. Gross weight and net weight are examples of real-time data. Tare weight, target, fine feed, and tolerance values are examples of static data.

The terminal can send a rotation of up to nine different real-time values for each scale. The PLC sends commands to the terminal to add a value to the rotation. Once the rotation is established, the PLC must instruct the terminal to begin its rotation automatically, or the PLC may control the pace of rotation by instructing the terminal to advance to the next value. If the terminal is asked to automatically alternate its output data, it will switch to the next value in its rotation at the next A/D update. (The A/D update rate depends on the scale type. An analog scale has an update rate of 20 Hz or 50 milliseconds.)

The PLC may control the rotation by sending alternate report next field commands (1 and 2). When the PLC changes to the next command, the terminal switches to the next value in the rotation. The terminal stores the rotation in its shared data so the rotation does not have to be re-initialized after each power cycle. When the PLC does not set up an input rotation, the default input rotation consists of gross weight only. See the floating-point rotation examples for additional information.

The following charts provide detailed information on the floating-point data format. Read data refers to the PLC's input data and write data refers to the PLC's output data.

3.5.2. Floating Point Data Format and Compatibility

3.5.2.1. Operational Overview

In Floating Point Message mode, the PLC and terminal exchange weight, target, and tare data in single-precision floating point format. The IEEE Standard for Binary Floating-Point Arithmetic,

ANSI/IEEE Standard 754-1985, specifies the format for single-precision floating point numbers. It is a 32-bit number that has a 1-bit sign, an 8-bit signed exponent, and a 23-bit mantissa. The 8-bit signed exponent provides scaling of weight and rate data. The 23-bit mantissa allows representation of 8 million unique counts.

Although the single-precision floating point number provides greater numerical precision and flexibility than integer weight representations, it has limitations. The weight representation may not be exact, particularly for the extended-resolution weight fields for high-precision bases.

Some Allen-Bradley PLCs require special integrity checking to communicate floating point numbers across DeviceNet. The Allen-Bradley PLC-5 must check two data integrity bits to verify the integrity of the floating point data it reads from the terminal. Allen-Bradley SLC programs always read valid floating-point data from the terminal and do not have to make special checks to guarantee the validity of the floating-point data.

The two integrity bits function as follows when communicating with the Allen-Bradley PLC-5 DeviceNet scanner card. One bit is in the beginning byte of the data; the second is in the ending byte of the data for a scale slot. The PLC program must verify that both data integrity bits have the same polarity for the data in the scale slot to be valid. There is a possibility that the PLC program will see several consecutive invalid reads when the terminal is freely sending weigh updates to the PLC-5 program detects this condition, it should send a new command to the terminal.

The Allen-Bradley SLC PLC programs do not have to make special checks to guarantee the validity of the floating-point data.

Examples of the Floating Point command sequence are shown in Appendix B.

3.5.3. Controlling the Discrete I/O Using a PLC Interface

The IND560 terminal provides the ability to directly control some of its discrete outputs and read some of its discrete inputs via the (digital) PLC interface options. System integrators should be aware that the terminal's discrete I/O updates are synchronized with the terminal's A/D rate and not with the PLC I/O scan rate. This may cause a noticeable delay in reading inputs or updating outputs as observed from the PLC to real world signals. Consult the IND560 Terminal Technical Manual for discrete I/O wiring. Also note that the outputs must be unassigned in the IND560 terminal setup.

3.6. Hardware Setup

3.6.1. Wiring

The IND560 wiring is shown in **Figure 3-3** and Table 3-8. Consult <http://www.odva.org/> for additional DeviceNet wiring information.



Figure 3-3: DeviceNet Connector Pin Numbering

Table 3-8: DeviceNet Pin Number and Corresponding Wiring

Pin Number	Description	Wire Color
1	V –	Black
2	CAN L	Green
3	Drain	
4	CAN H	White
5	V +	Red

3.7. Software Setup

The IND560 terminal automatically detects the presence of a DeviceNet option board if one is installed. When the option is detected, the IND560 terminal adds the DeviceNet parameters in a program block under **Communications > PLC**. Figure 3-4 graphs the DeviceNet and PLC Data Format program blocks.

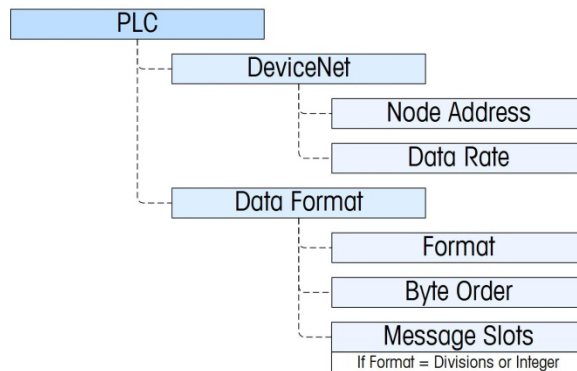

Figure 3-4: The DeviceNet Program Block and Data Format Setup Block

3.7.1. DeviceNet Setup Blocks

3.7.1.1. DeviceNet setup

In Setup, access **Communication > PLC Interface > DeviceNet**. Enter the Node Address field and set an address, from 0 to 63. The address should be unique in the DeviceNet network. Choose the desired Data Rate: 125Kb, 250Kb or 500Kb

3.7.1.2. Data Format setup

3.7.1.2.1. Format

In Setup, access **Communication > PLC Interface > Data Format**. Format may be selected from a drop-down list. Choose Divisions, Integer (default) or Floating Point.

3.7.1.2.2. Byte Order

Available selections are Standard, Byte Swap, Word Swap (default), and Double Word Swap. See Table 3-3 for definitions.

3.7.1.2.3. Message Slots

If Divisions or Integer is selected for Data Format, the Message Slots option appears. Choose 1 or 2 slots.

3.8. Troubleshooting

All DeviceNet nodes are required to have 2 status LED's. These LED's (labeled in Figure 3-2) indicate module and network status. Refer to the definitions below.

3.8.1. Module status LED (MS)

This LED displays the status of the IND560 Terminal DeviceNet board.

Table 3-9: Module Status LED Indications

LED State	Meaning
Solid Green	Normal operation
Flashing Green	DeviceNet board fault
OFF	No power to the DeviceNet board
Solid Red	Unrecoverable board fault
Flashing Red	Recoverable fault
Flashing Orange	Board performing self-test

- Note: If the module status LED indicates anything after powering up the unit and attaching the DeviceNet cable, the IND560 Terminal must be powered down and restarted. If the LED continues to show a condition other than solid green, replace the board.

3.8.2. Network status LED (NS)

This LED displays network status.

Table 3-10: Network Status LED Indications

LED State	Meaning
Solid Green	Node is communicating to scanner
Flashing Green	Device is connected to the network but not being scanned The most common reason for this is the device has not been added to the scan list. Consult DeviceNet configuration tool's help in order to commission the node and put it in the scan list.
OFF	No DeviceNet power
Solid Red	Critical Link error This error typically indicates a cable problem
Blinking Red	Connection Timeout

3.9. DeviceNet Option Kit

No spare parts are associated with the DeviceNet option kit. The kit CIMF part number is 72193580. Table 3-11 shows what comes in the kit.

Table 3-11: DeviceNet Option Kit

Description	Qty.
Installation Instructions	1
PCB Package	1
Installation Kit	1
Gland Kit	1

3.10. DeviceNet Commissioning and Configuration Examples

The user must register the EDS, connect the device and add the IND560 Terminal to the DeviceNet master's scanlist. Note that every vendor's software is different. Depending upon master and software, the user may have to cycle power on the master in order to complete the commissioning of any device added to the network. Consult the master's documentation for more information. The following example is for Rockwell software and Logix5000 processor.

3.10.1. Configuring the IND560 Terminal with RSNetWorx for DeviceNet

The EDS file located on the CD-ROM supplied with the IND560 Terminal contains configuration information to allow RSNetWorx for DeviceNet to set up a single polled I/O connection between a

METTLER TOLEDO IND560 Terminal and DeviceNet master/scanner. Note that this order of operations isn't the only way of configuring the IND560 terminal.

3.10.1.1. Registering the EDS file

The EDS file must first be registered into RSNetWorx for DeviceNet. This is accomplished using the EDS Wizard.

To access the EDS Wizard:

1. Click Iools then EDS Wizard... to begin the registration process.

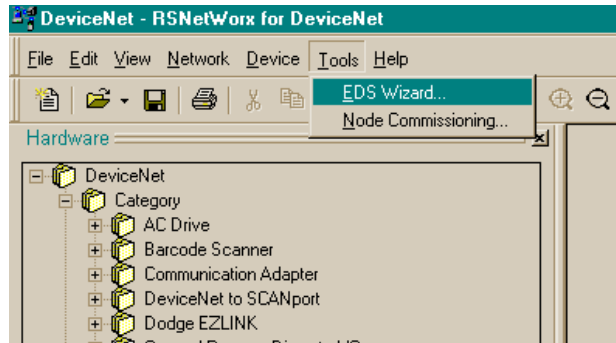

Figure 3-5: Accessing the EDS Wizard

2. The EDS Wizard Welcome screen appears.

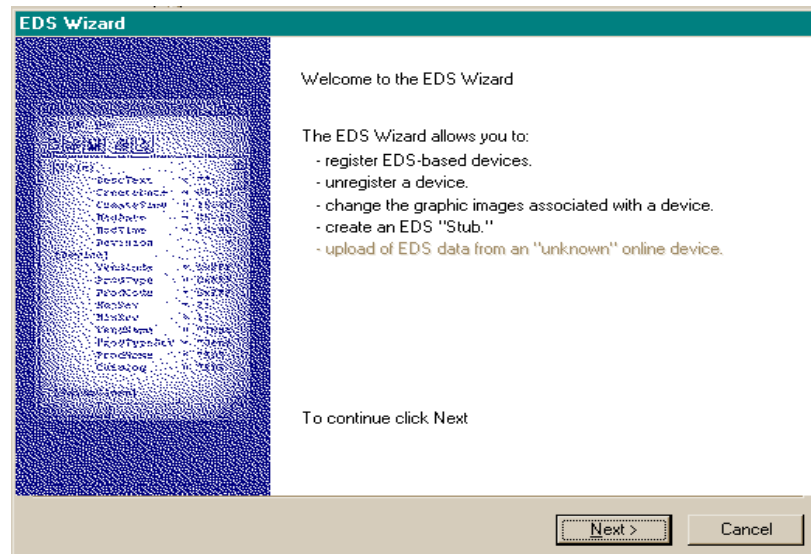

Figure 3-6: EDS Wizard Welcome

3. Click Next to begin the registration process.

- In the Options screen, make sure the Register an EDS file(s) radio button is selected.

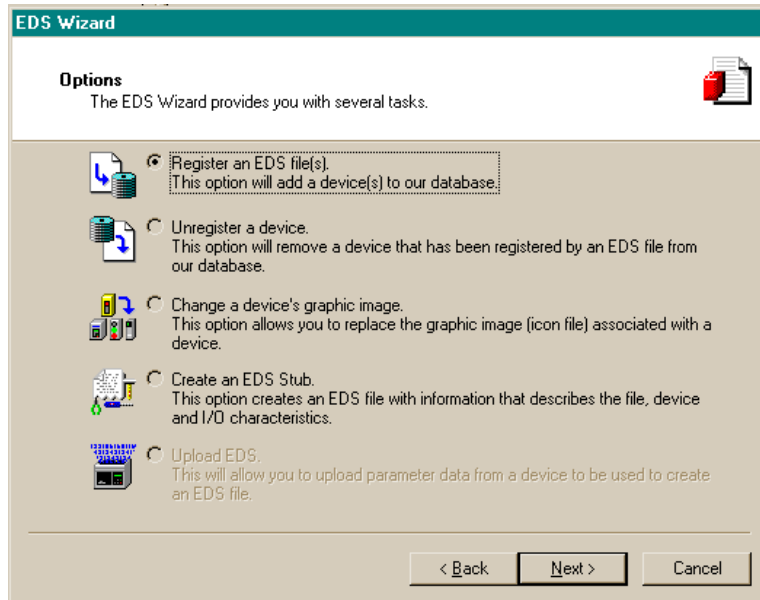

Figure 3-7: EDS Wizard Options Screen

- Click Next, then Browse to select a file to register.
- Browse to the appropriate location and select the file MT_IND-DNET.eds. (The EDS file is located on the CD-ROM.) Click the Open button.
- Confirm that the correct file is showing in the Named: field, then click Next.

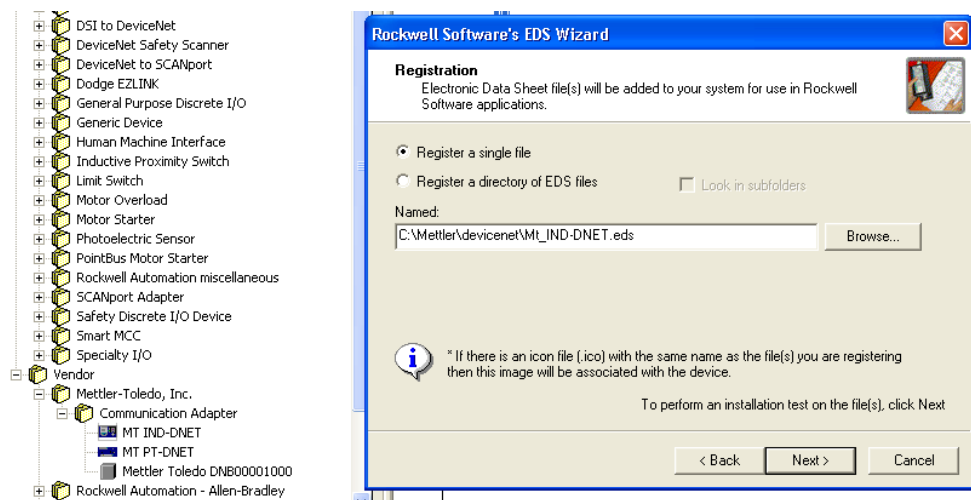

Figure 3-8: File Selected, Ready to Register

8. Acknowledge the error applet. This error is generated due to the EDS file being generic for other MT devices. The IO sizes will be configured later in the process.

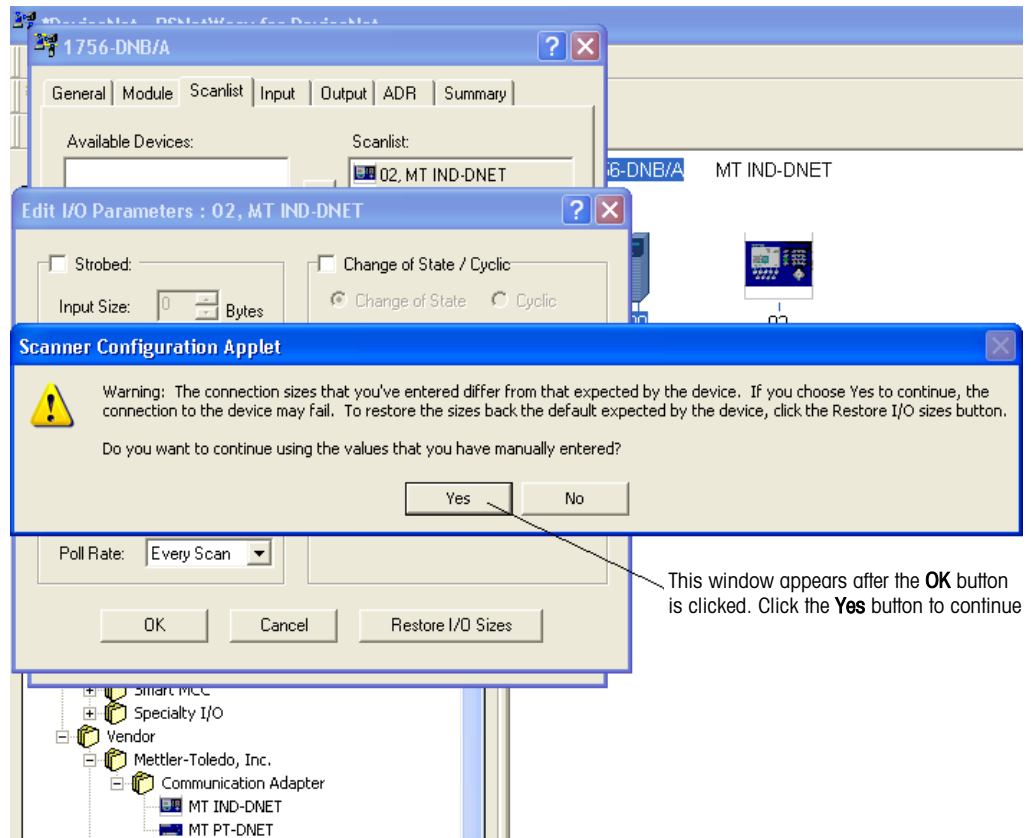

Figure 3-9: File Validity Confirmed

9. Ensure that the MT_IND-DNET.ico icon is selected.
 - Note: RSNetWorx for DeviceNet will not be able to find the icon unless it is in the same directory as the EDS file.

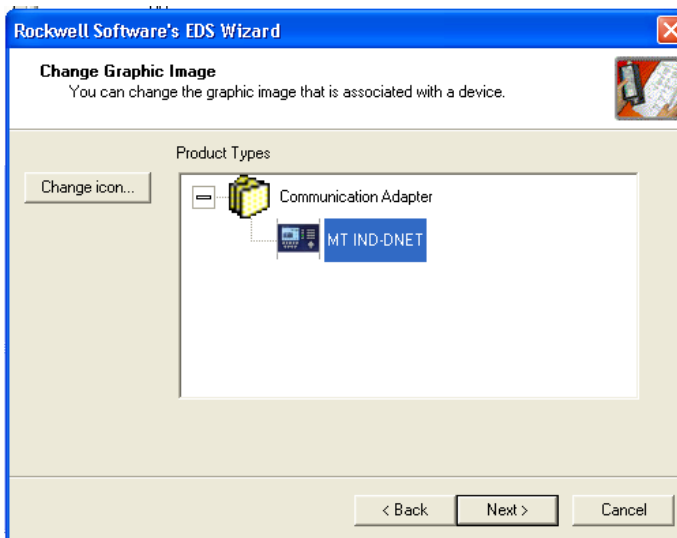

Figure 3-10: EDS Wizard Graphic Image (Icon) Selection

10. The Final Task Summary screen (Figure 3-11) will appear. Click Next.

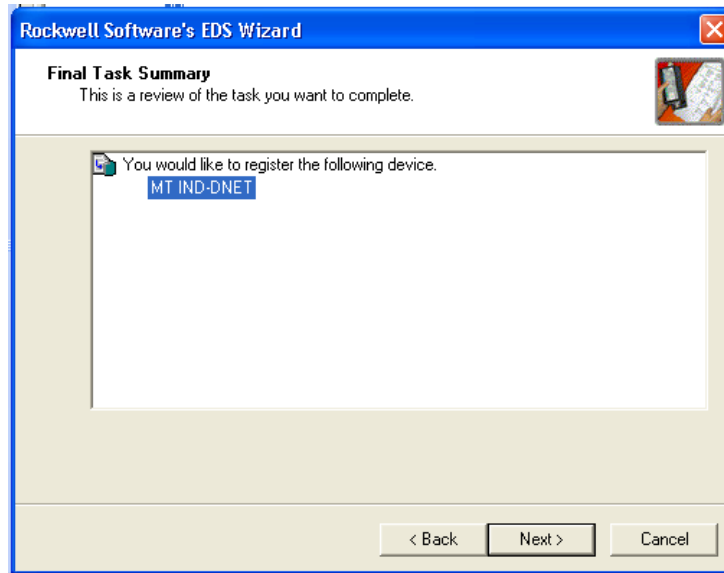

Figure 3-11: Final Task Summary Screen

3.10.1.2. Setting up an I/O Connection

After the EDS file has been registered, RSNetWorx is used to set up a polled connection between the METTLER TOLEDO IND Terminal and the DeviceNet master/scanner.

To set up the connection:

- Note: You must add the DeviceNet scanner card and choose the proper revision before going online.

1. Select Network then Online to browse the DeviceNet network.

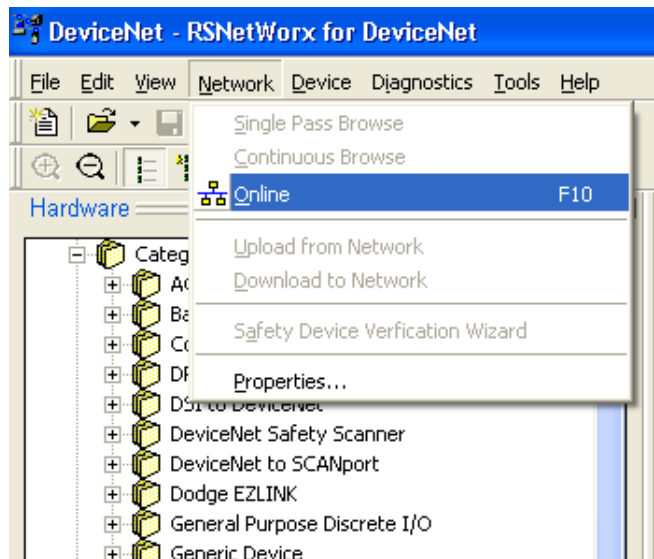

Figure 3-12: RSNetWorx Online Browse

2. Select the appropriate network path. In this case (Figure 3-13), 1756-DNB/A DeviceNet Scanner is selected.

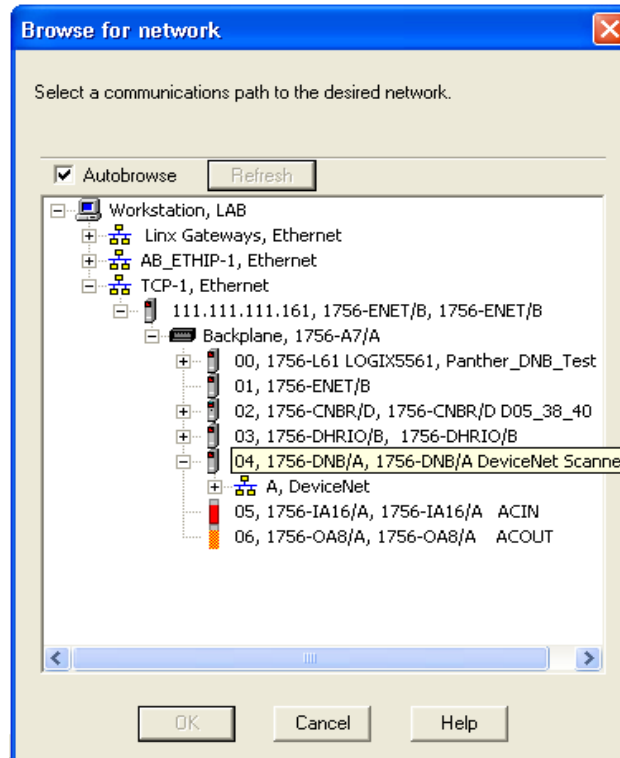

Figure 3-13: Browse for network

3. Click OK to continue. A dialog box like the one shown in Figure 3-14 will appear. Note that you may be asked to upload or download, depending on the version of software used.

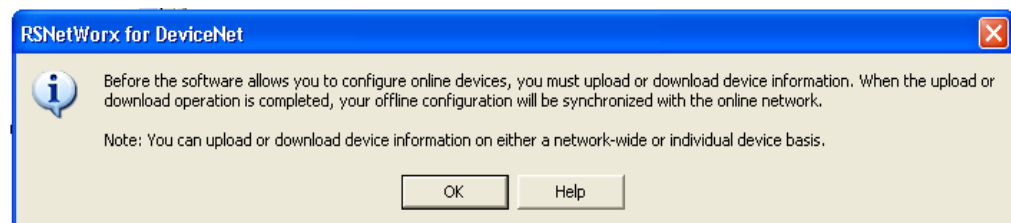

Figure 3-14: Confirmation Dialog Box

- Click OK in the dialog box. A Browsing network... box will display with a progress meter indicating that the process is underway.

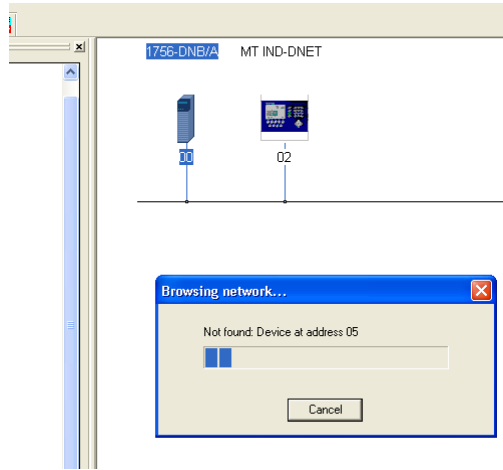

Figure 3-15: Browsing Network Underway

- Once the scanner has browsed the entire network, add IND Terminal to the 1756-DNB/A's scanlist by right-clicking on the scanner icon in the Graph window (note the tab at the bottom of Figure 3-16), and choosing Properties...

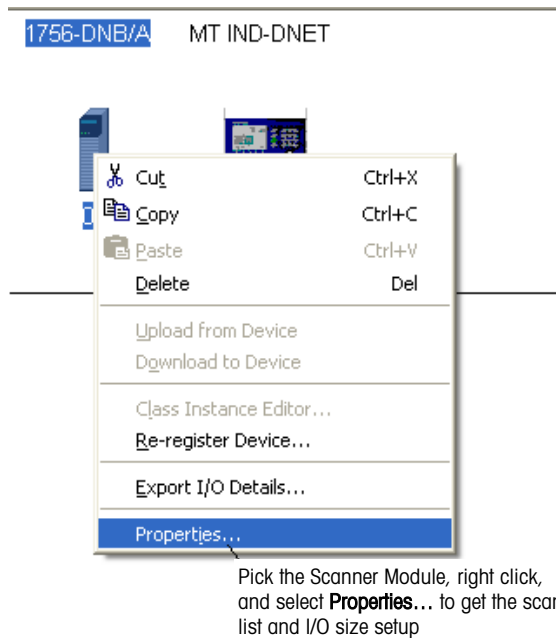

Figure 3-16: Accessing Scanner Properties

6. The scanner's properties dialog box will appear, as in Figure 3-17.

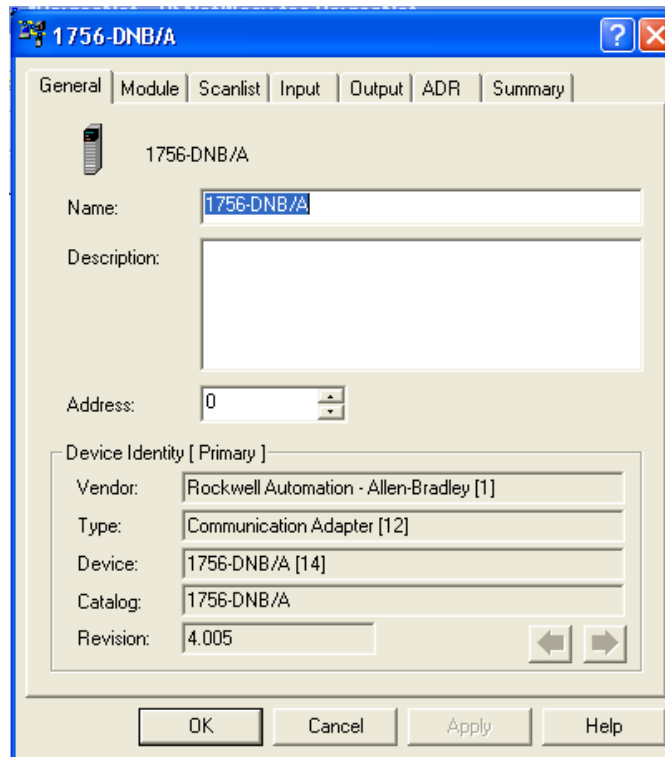

Figure 3-17: Scanner Properties Dialog: Initial View

7. Click the Scanlist tab in the properties dialog box. The view shown in Figure 3-18 will appear.

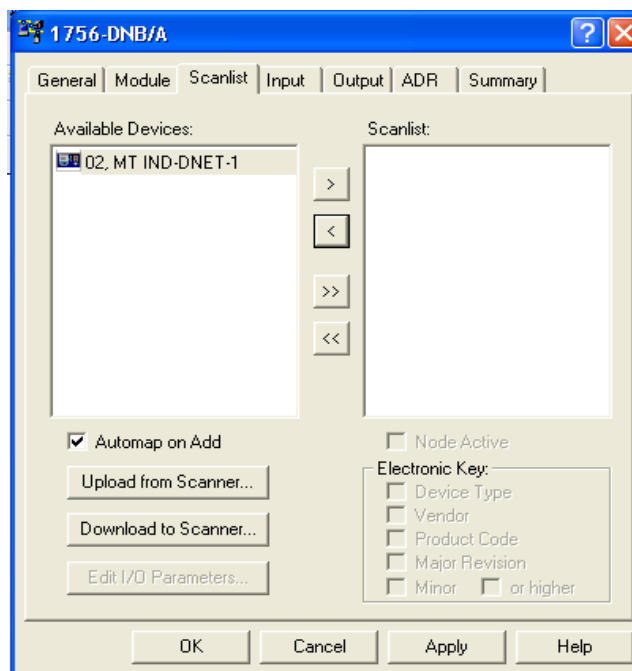

Figure 3-18: Scanner Properties Dialog: Scanlist Tab Showing

8. Highlight the IND Terminal (MT IND-DNET) and left-click to add it to the Scanlist. Once the IND Terminal is added, it will appear in the right pane (Figure 3-19). Click OK.

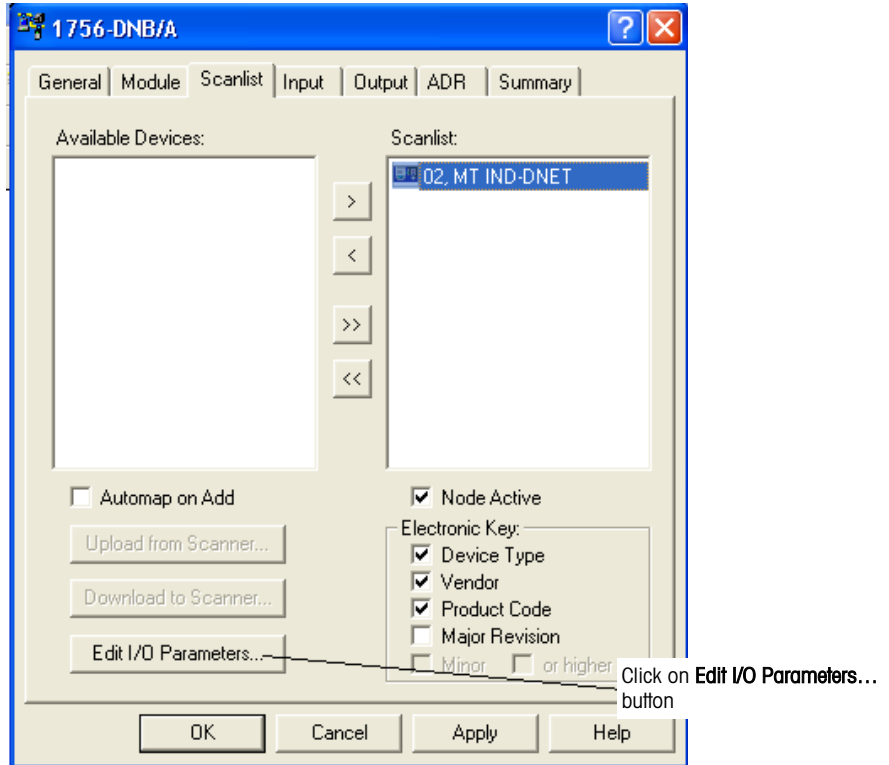

Figure 3-19: IND Terminal Added to Scanlist

9. The next step is to edit the I/O parameters of the IND terminal. The I/O size depends on the data type and the number of slots selected in the terminal. Note that 'slots' is a terminal phrase that is not used in typical DeviceNet terms; it was derived from previous PLC memory mapping. It is used in the terminal setup to remain consistent across the Mettler Toledo terminal line. Integer or Divisions with one slot will be 4 bytes/in 4 bytes out. Integer or Division with 2 slots is 8 bytes in/8 bytes out. Float is always 8 bytes in and out.

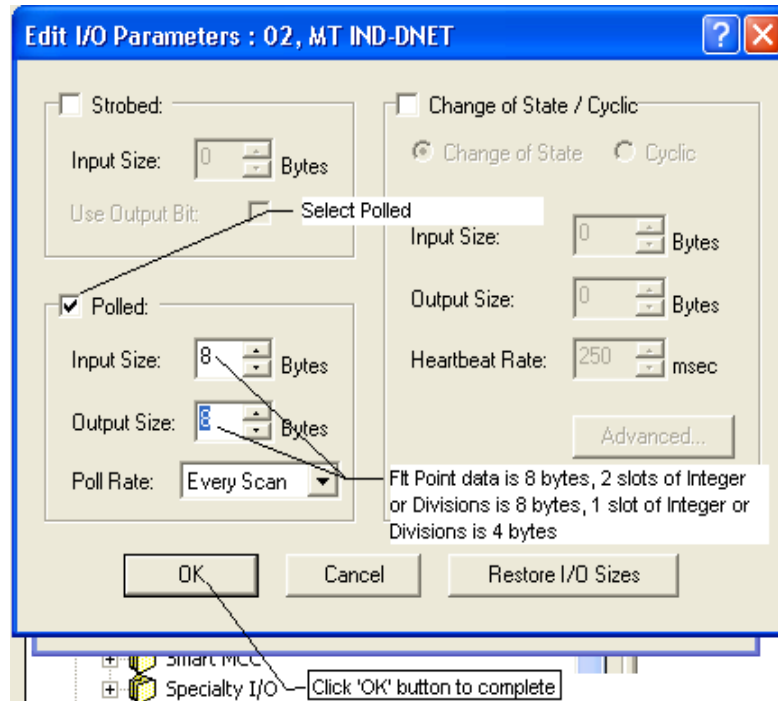

Figure 3-20: Editing I/O Parameters

- Download the configuration to the scanner card, in order to commission the network. In the prompt that appears (Figure 3-21), click Yes to continue. Note that some scanner cards may require power down for changes to take effect.

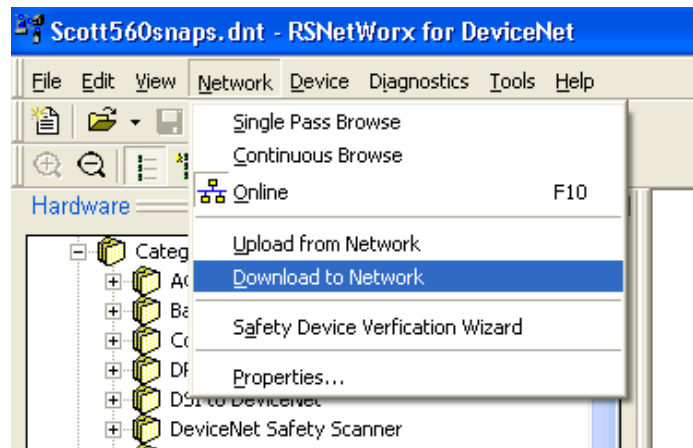

Figure 3-21: Network Download Confirmation Prompt

Once the IND Terminal has been added to the scanlist, access the Properties dialog to verify its I/O mapping (Figure 3-22 and Figure 3-23) within the scanner card. Note that auto or manual

mapping can be used. Consult the master’s documentation for advance I/O mapping options. If manual mapping is used, be sure to start with an unused section of memory for offset.

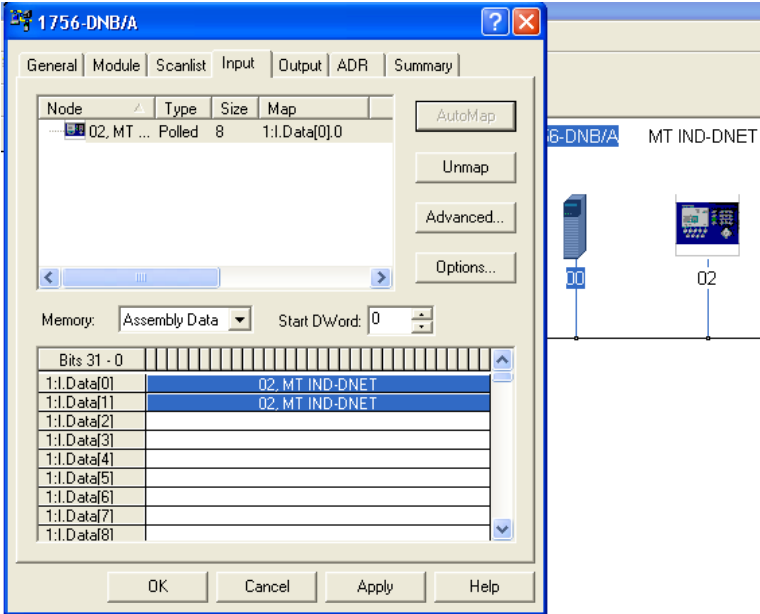

Figure 3-22: IND Terminal Mapping

11. Verify that I/O mapping is complete by choosing the summary tab. Note that the Mapped columns show Yes for the IND Terminal.

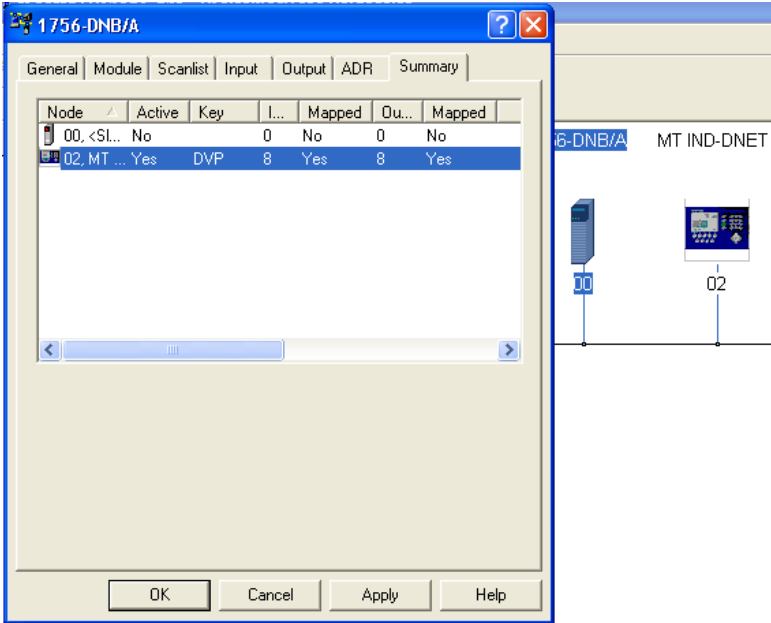

Figure 3-23: Summary Tab

3.10.2. PLC Programming

The IND Terminal is now ready to communicate to the master or DeviceNet scanner. You must configure the PLC or other master with DeviceNet scanner to send and receive data via polled

messaging. For this example the RSLogix5000 software is used in conjunction with the ControlLogix5000 processor with DeviceNet scanner card. Note that these examples may or may not be applicable depending upon whether you have an existing program or different version of software.

1. Create a new project.

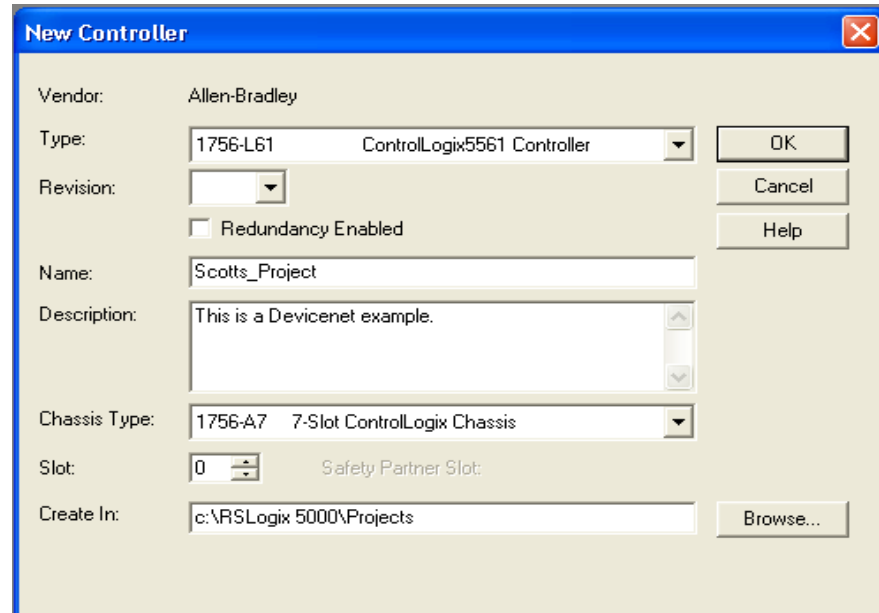

Figure 3-24: New Project Dialog

2. Add DeviceNet scanner card to existing chassis.

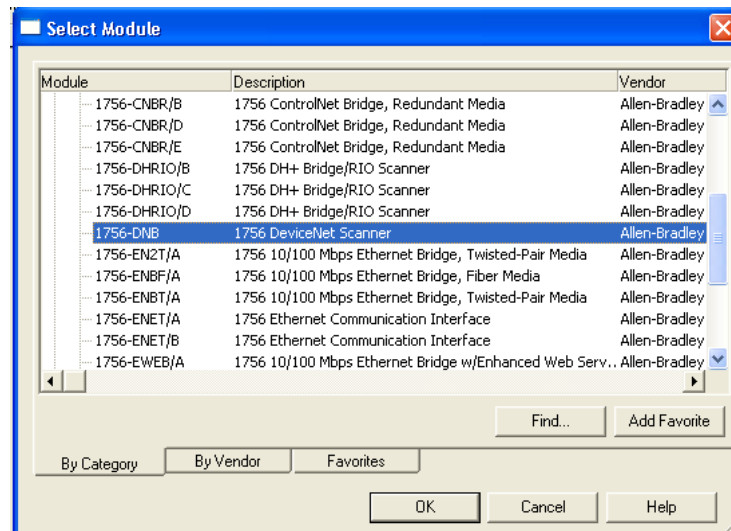

Figure 3-25: Adding DeviceNet Scanner

3. Configure scanner card. Refer to Rockwell software documentation for more information.

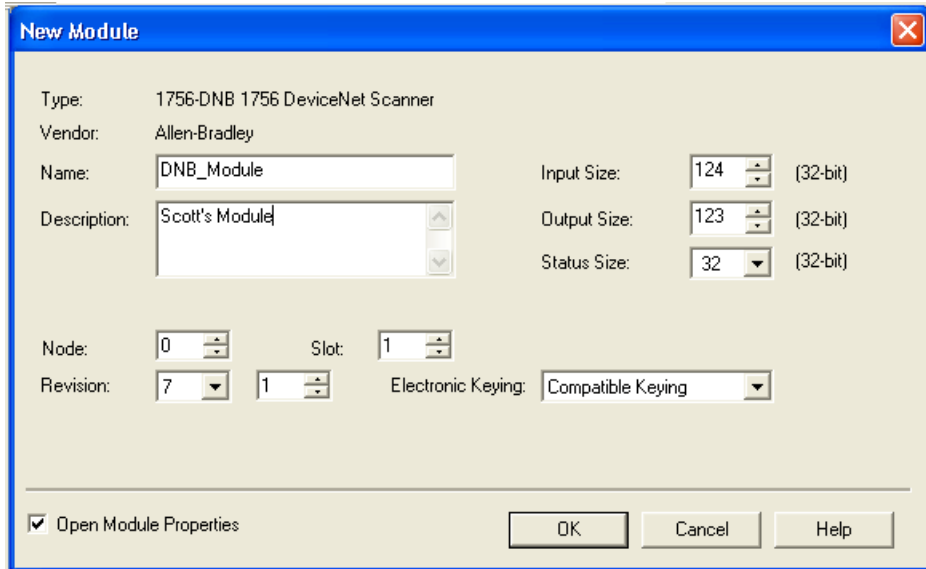

Figure 3-26: Ready to Go Online

4. Create User-Defined tags. These are under data type. In this example the Integer Data Format is being used; create these tags in order to get the data from the scanner's memory location into a useable/readable format. Create 2 tags. One is for the weight data (single 16 bit integer) that can be read in decimal format and the other is for the status information (16 bit value) this is read in binary. User-Defined tags will be different for the Floating Point Data Format.

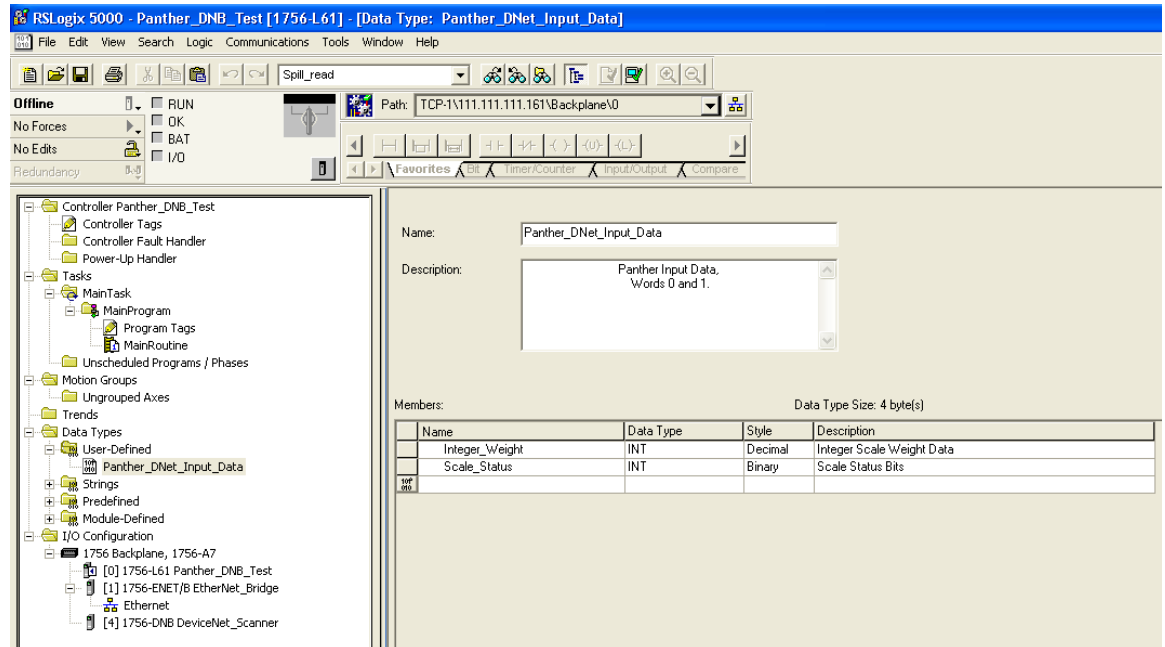

Figure 3-27: Creating User-Defined Tags

5. Create an unconditional rung of logic that activates the command register run bit. This bit is required to activate the DeviceNet scanner card. Then create another unconditional rung that activates the copy command. Copy the scanner's I/O mapped data into the user defined tags.

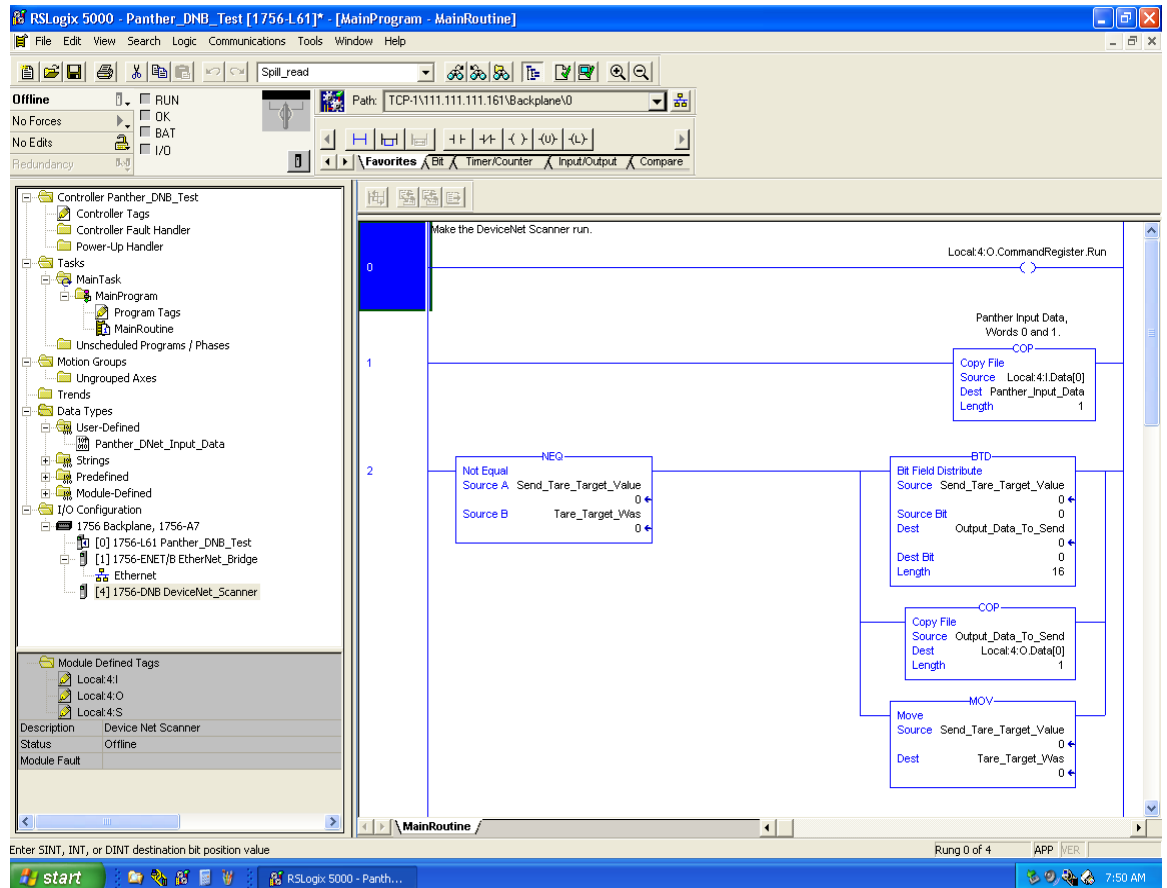

Figure 3-28: Creating an Unconditional Rung

6. At this point you can download the program and run it and, provided the wiring and configuration are correct, you will receive weight and status information back from the IND560 Terminal.
 - Note that examples, and the EDS and IND Terminal icon files, are located on the IND560 documentation CD that comes with every unit.

4 EtherNet/IP™ Interface

4.1. Overview

EtherNet/IP, short for "EtherNet Industrial Protocol," is an open industrial networking standard that takes advantage of commercial, off-the-shelf EtherNet communication chips and physical media. This networking standard supports both implicit messaging (real-time I/O messaging) and explicit messaging (message exchange). The protocol is supported by ControlNet International (CI), the Industrial Ethernet Association (IEA) and the Open DeviceNet Vendor Association (ODVA).

EtherNet/IP utilizes commercial, off-the-shelf EtherNet hardware (for example, switches and routers) and is fully compatible with the Ethernet TCP/IP protocol suite. It uses the proven Control and Information Protocol (CIP) to provide control, configuration, and data collection capability.

The kit enables the IND560 terminal to communicate to EtherNet/IP Programmable Logic Controllers (PLCs) through direct connection to the EtherNet/IP network at either 10 or 100 Mbps speed. The kit consists of a backplane-compatible I/O module, mounting hardware, and a ferrite. Software to implement the data exchange resides in the IND560 terminal.

The EtherNet/IP Kit option has the following features:

- User-programmable IP addressing.
- Capability for bi-directional discrete mode communications (Class 1 Messaging) of weight or display increments, status, and control data between the PLC and the IND560.

Figure 4-1 and Figure 4-2 show an EtherNet/IP module and its components. Note that the module's address is set in software (see Figure 4-3), and the DIP switches indicated in Figure 4-2 must all be set to OFF.

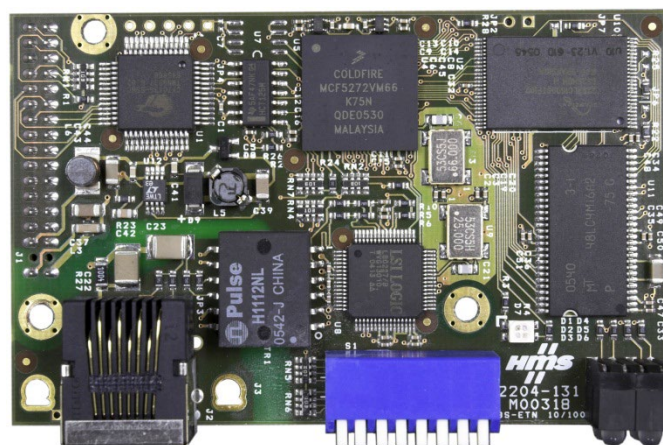

Figure 4-1: EtherNet/IP Module

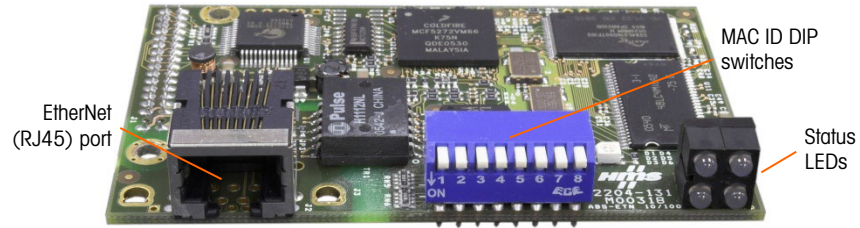

Figure 4-2: EtherNet/IP Module Components

4.1.1. Definition of Terms

Some terms (such as Target) used by the EtherNet/IP PLC application have a different sense from their use by the IND560 terminal. Table 4-1 provides definitions specific to EtherNet/IP.

Table 4-1: EtherNet/IP Definition of Terms

Term	Definition
Adapter Class	An Adapter Class product emulates functions provided by traditional rack-adapter products. This type of node exchanges real-time I/O data with a Scanner Class product. It does not initiate connections on its own.
Class 1 Messaging	In EtherNet/IP communication protocol scheduled (cyclic) message transfer between a PLC and CIP Adapter Class device.
Class 3 Messaging	In EtherNet/IP communication protocol unscheduled message transfer between a PLC and CIP Adapter Class device. This is used by the IND560 for explicit messaging.
Connected Messaging	A connection is a relationship between two or more application objects on different nodes. The connection establishes a virtual circuit between end points for transfer of data. Node resources are reserved in advance of data transfer and are dedicated and always available. Connected messaging reduces data handling of messages in the node. Connected messages can be Implicit or Explicit. See also Unconnected Messaging.
Connection Originator	Source for I/O connection or message requests. Initiates an I/O connection or explicit message connection.
Explicit Messaging	Explicit Messages can be sent as a connected or unconnected message. CIP defines an Explicit Messaging protocol that states the meaning of the message. This messaging protocol is contained in the message data. Explicit Messages provide a one-time transport of a data item. Explicit Messaging provide the means by which typical request/response oriented functions are performed (e.g. module configuration). These messages are typically point-to-point.

Term	Definition
Implicit Messaging	Implicit Messages are exchanged across I/O Connections with an associated Connection ID. The Connection ID defines the meaning of the data and establishes the regular/repeated transport rate and the transport class. No messaging protocol is contained within the message data as with Explicit Messaging. Implicit Messages can be point-to-point or multicast and are used to transmit application-specific I/O data. This term is used interchangeably with the term I/O Messaging.
I/O Client	Function that uses the I/O messaging services of another (I/O Server) device to perform a task. Initiates a request for an I/O message to the server module. The I/O Client is a Connection Originator.
I/O Messaging	Used interchangeably with the term Implicit Messaging.
I/O Server	Function that provides I/O messaging services to another (I/O Client) device. Responds to a request from the I/O Client. I/O Server is the target of the connection request.
Message Client	Function that uses the Explicit messaging services of another (Message Server) device to perform a task. Initiates an Explicit message request to the server device.
Message Server	Function that provides Explicit messaging services to another (Message Client) device. Responds to an Explicit message request from the Message Client.
Scanner Class	A Scanner Class product exchanges real-time I/O data with Adapter Class and Scanner Class products. This type of node can respond to connection requests and can also initiate connections on its own.
Target	Destination for I/O connection or message requests. Can only respond to a request, cannot initiate an I/O connection or message.
Unconnected Messaging	Provides a means for a node to send message requests without establishing a connection prior to data transfer. More overhead is contained within each message and the message is not guaranteed destination node resources. Unconnected Messaging is used for non-periodic requests (e.g. network "Who" function). Explicit messages only. See also Connected Messaging.

4.1.2. Communications

The IND560 terminal utilizes component parts to ensure complete compatibility with the Allen-Bradley EtherNet/IP network. An IND560 terminal is recognized as a generic EtherNet/IP device by the PLC.

Each EtherNet/IP option connected to the EtherNet/IP network represents a physical IP Address. The connection is made via a RJ-45 connector on the option card (see Figure 4-2).

The wiring between the PLC and the IND560 EtherNet/IP connection uses EtherNet twisted pair cable. The cable installation procedures and specification including distance and termination requirements are the same as recommended by Allen-Bradley for the EtherNet/IP network.

The IND560 only uses Class 1 cyclic data for discrete data and explicit messages for access to the IND560 Shared Data Variables. Explicit message blocks may be connected or unconnected; the PLC programmer must make this choice.

4.1.3. IP Address

Each EtherNet/IP option represents one physical IP Address. This address is chosen by the system designer, and then programmed into the IND560 terminal and PLC. There is no feature for EtherNet/IP to use a host server to assign addresses. The IND560 terminal's address is programmed through **Communication > PLC Interface > EtherNet/IP** in the setup menu. IND560 IP Address entry must be unique for each IND560.

4.1.4. Data Formats

The EtherNet/IP Kit option provides discrete data transfer, Class 1 messaging. Discrete data is continuously available. The EtherNet/IP option has its own logical IP address to send and receive information to and from the PLC. There are three data formats: Integer, Divisions and Floating Point.

- **Integer** – reports scale weight as a signed 16 bit integer (± 32767).
- **Divisions** – reports scale weight in display divisions (± 32767). The PLC multiplies the reported divisions by the increment size to calculate the weight in display units.
- **Floating Point** – displays weight in floating point data format

Appendix A and B provide detailed information on data formats.

4.2. Data Definition

The EtherNet/IP Kit option uses discrete data for its communication with PLCs. Data transfer is accomplished via the PLC's cyclic messaging.

4.2.1. Data Integrity

The IND560 has specific bits to allow the PLC to confirm that data was received without interruption and that the IND560 is not in an error condition. It is important to monitor these bits. Any PLC code should use them to confirm the integrity of the data received by the IND560. Refer to the data charts for specific information regarding the Data OK, Update in Progress and Data Integrity bits and their usage.

4.2.2. Assembly Instances of Class 1 Cyclic Communications

Class 1 cyclic communications is used for transfer of Discrete Data between the PLC and the IND560.

The PLC Input Assembly Instance is 100 (decimal). This instance is used for all Data Formats and data size requirements.

The PLC Output Assembly Instance is 150 (decimal). This instance is used for all Data Formats and data size requirements.

The IND560 uses data only. Configuration data is not used or required. Within the PLC EtherNet/IP Interface setup set the Configuration Instance to 1 and the data size to zero.

The EDS file provided on the Documentation CD has no Assembly Instance or data size limitations. The IND560 programming controls the Assembly Instance and data size limitations.

4.2.3. Discrete Data

Three formats of discrete data are available with the EtherNet/IP interface option: integer (default), divisions and floating point.

The data format of discrete data will affect the data size required in the configuration of the PLC. The IND560 console PLC message slot setup screen provides data size requirements in bytes.

Selection of the appropriate format depends on issues such as the range or capacity of the scale used in the application. The integer format can represent a numerical value up to 32,767. The division format can represent a value up to 32,767 scale divisions or increments. The floating-point format can represent a value encoded in IEEE 754, single precision floating point format.

Floating point is the only data format that includes decimal point information. Integer and division formats ignore decimal points. Accommodation of decimal point location must take place in the PLC logic, when it is needed with these formats.

Changing the Data Format to be used by the IND560 will clear all Message Slots. Data format is selected in the **Communication > PLC > Data Format** setup block, see Figure 4-3.

4.2.3.1.1. Examples

250 x .01 scale				
IND560 Displays:	0	2.00	51.67	250.00
Format sent:				
Integer	0	200	5167	25000
Division	0	200	5167	25000
Floating Point	0	2.00	51.67	250.00

Any of the formats could be used in this case.

50,000 x 10 scale				
IND560 Displays:	0	200	5160	50000
Format sent:				
Integer	0	200	5160	-(15536)
Division	0	20	516	5000
Floating Point	0	200	5160	50000

The integer format could not be used because it would send a negative value once the weight exceeded 32,767.

150 x .001 scale				
IND560 Displays:	0	2.100	51.607	150.000
Format sent:				
Integer	0	2100	-(13929)	18928
Division	0	2100	-(13929)	18928
Floating Point	0	2.100	51.607	150.000

The integer and division formats could not be used because they would send a negative or invalid value once the weight exceeded 32.767.

4.2.4. Byte Order

The byte order parameter sets the order in which the data bytes and words will be presented in the PLC data format. Available byte orders are:

- Word Swap - (default) Make the data format compatible with RSLogix 5000 processors.
- Byte Swap - Makes the data format compatible with S7 Profibus.
- Standard – Makes the data format compatible with PLC 5
- Double Word Swap - Makes the data format compatible with the Modicon Quantum PLC for Modbus TCP networks.

Table 4-2 provides examples of the various byte ordering.

- Note: Byte Order was introduced into the IND560 in firmware version 3.xx. Terminals running firmware versions earlier than v3.xx will not see a setting for Byte Order in their setup selections.

Table 4-2: PLC Data Byte Ordering

		Word Swap			Byte Swap			Double Word Swap			Standard		
Terminal Weight Value		1355											
PLC		15	Bit #	0	15	Bit #	0	15	Bit #	0	15	Bit #	0
Integer	Weight value word	0x054B Hex			0x4B05 Hex			0x4B05 Hex			0x054B Hex		
Floating Point	1st Weight value word	0x6000 Hex			0xA944 Hex			0x0060 Hex			0x44A9 Hex		

		Word Swap			Byte Swap			Double Word Swap			Standard		
Terminal Weight Value		1355											
PLC		15	Bit #	0	15	Bit #	0	15	Bit #	0	15	Bit #	0
	2nd Weight value word	0x44A9 Hex			0x0060 Hex			0xA944 Hex			0x6000 Hex		

4.2.5. Message Slots

There may be up to 4 message slots for discrete data transfer, Class 1 messaging, in Integer, Divisions and Floating Point Data Formats. Each message slot represents the scale but may be controlled by the PLC to present different data in each message slot. The integer and division formats provide two 16-bit words of input and two 16-bit words of output data per Slot. Each Message Slot's first input word provides scale weight data. The type of data displayed, such as Gross, Tare, etc., is selected by the PLC using the Message Slot's second output word bits 0, bit 1 and bit 2. The following two Tables provide input and output usage information.

The data format for the slots are described in Appendix A and B.

Table 4-3: EtherNet/IP PLC Input Data and Data Usage (Integer and Division)

PLC Input Bytes	PLC Input Words	Usage
0	0	Message Slot 1 Weight Data
1		Message Slot 1 Weight Data
2	1	Message Slot 1 Scale Status
3		Message Slot 1 Scale Status
4	2	Message Slot 2 Weight Data
5		Message Slot 2 Weight Data
6	3	Message Slot 2 Scale Status
7		Message Slot 2 Scale Status
8	4	Message Slot 3 Weight Data
9		Message Slot 3 Weight Data
10	5	Message Slot 3 Scale Status
11		Message Slot 3 Scale Status
12	6	Message Slot 4 Weight Data
13		Message Slot 4 Weight Data
14	7	Message Slot 4 Scale Status
15		Message Slot 4 Scale Status

Table 4-4: EtherNet/IP PLC Output Words and Word Usage (Integer and Division)

PLC Output Bytes	PLC Output Words	Usage
0	0	Message Slot 1 Weight Data
1		Message Slot 1 Weight Data
2	1	Message Slot 1 Scale Command
3		Message Slot 1 Scale Command
4	2	Message Slot 2 Weight Data

PLC Output Bytes	PLC Output Words	Usage
5		Message Slot 2 Weight Data
6	3	Message Slot 2 Scale Command
7		Message Slot 2 Scale Command
8	4	Message Slot 3 Weight Data
9		Message Slot 3 Weight Data
10	5	Message Slot 3 Scale Command
11		Message Slot 3 Scale Command
12	6	Message Slot 4 Weight Data
13		Message Slot 4 Weight Data
14	7	Message Slot 4 Scale Command
15		Message Slot 4 Scale Command

The floating point format provides four 16-bit words of input data and three 16-bit words of output data) per Message Slot. See Table 4-5 and *Refer to the Message Slot Table in Appendix B for details

Table 4-6 for details.

The number of Message Slots is selected in the **Communication > PLC > Data Format** setup menu, Figure 4-3.

The format of the data is shown in Appendix B

Table 4-5: EtherNet/IP PLC Floating Point Input Words

PLC Input Words	Bits 0 – 7	Bits 8 – 15
0	Message Slot 1: Reserved	Message Slot 1: Command Response
1	Message Slot 1: Floating Point data	Message Slot 1: Floating Point data
2	Message Slot 1: Floating Point data	Message Slot 1: Floating Point data
3	Message Slot 1: Scale Status	Message Slot 1: Scale Status
4	Message Slot 2: Reserved	Message Slot 2: Command Response
5	Message Slot 2: Floating Point data	Message Slot 2: Floating Point data
6	Message Slot 2: Floating Point data	Message Slot 2: Floating Point data
7	Message Slot 2: Scale Status	Message Slot 2: Scale Status
8	Message Slot 3: Reserved	Message Slot 3: Command Response
9	Message Slot 3: Floating Point data	Message Slot 3: Floating Point data
10	Message Slot 3: Floating Point data	Message Slot 3: Floating Point data
11	Message Slot 3: Scale Status	Message Slot 3: Scale Status
12	Message Slot 4: Reserved	Message Slot 4: Command Response
13	Message Slot 4: Floating Point data	Message Slot 4: Floating Point data
14	Message Slot 4: Floating Point data	Message Slot 4: Floating Point data
15	Message Slot 4: Scale Status	Message Slot 4: Scale Status

*Refer to the Message Slot Table in Appendix B for details

Table 4-6: EtherNet/IP PLC Floating Point Output Words

PLC Output Bytes	PLC Output Words	Usage
0	0	Reserved
1		Reserved
2	1	Message Slot 1: Command
3		Message Slot 1: Command
4	2	Message Slot 1: Floating Point data
5		Message Slot 1: Floating Point data
6	3	Message Slot 1: Floating Point data
7		Message Slot 1: Floating Point data
8	4	Message Slot 2: Command
9		Message Slot 2: Command
10	5	Message Slot 2: Floating Point data
11		Message Slot 2: Floating Point data
12	6	Message Slot 2: Floating Point data
13		Message Slot 2: Floating Point data
14	7	Message Slot 3: Command
15		Message Slot 3: Command
16	8	Message Slot 3: Floating Point data
17		Message Slot 3: Floating Point data
18	9	Message Slot 3: Floating Point data
19		Message Slot 3: Floating Point data
20	10	Message Slot 4: Command
21		Message Slot 4: Command
22	11	Message Slot 4: Floating Point data
23		Message Slot 4: Floating Point data
24	12	Message Slot 4: Floating Point data
25		Message Slot 4: Floating Point data

4.2.5.1. Floating Point Data Format and Compatibility

In Floating Point Data Format, the PLC and IND560 terminal exchange weight, target, and tare data in single-precision floating-point format. The IEEE Standard for Binary Floating-Point Arithmetic, ANSI/IEEE Standard 754-1985, specifies the format for single-precision floating point numbers. It is a 32-bit number that has a 1-bit sign, an 8-bit signed exponent, and a 23-bit mantissa. The 8-bit signed exponent provides scaling of weight data. The 23-bit mantissa allows representation of 8 million unique counts.

Although the single-precision floating point number provides greater numerical precision and flexibility than integer weight representations, it has limitations. The weight representation may not be exact, particularly for the extended-resolution weight fields for high-precision bases.

There are two data integrity bits that the IND560 uses to maintain data integrity when communicating with the PLC. One bit is in the beginning word of the data; the second is in the

ending byte of the data for a scale slot. The PLC program must verify that both data integrity bits have the same polarity for the data in the scale slot to be valid. There is a possibility that the PLC program will see several consecutive invalid reads when the terminal is freely sending weigh updates to the PLC, if the PLC program detects this condition, it should send a new command to the terminal.

The Allen-Bradley SLC PLC programs do not have to make special checks to guarantee the validity of the floating-point data.

The method of handling string and floating point data varies between Allen-Bradley PLC generations.

4.2.5.2. Shared Data Mode

The Shared Data mode PLC communications is provided using CIP explicit messages.

The IND560 Shared Data document lists the Shared Data Variables available to EtherNet/IP. This document also includes the hex Class Code, Instance and Attribute for the shared data. The PLC must use Get Attribute Single (0e hex) to read a Shared Data Variable and Set Attribute Single (10 hex) to write a Shared Data Variable.

4.2.6. Controlling the Discrete I/O Using a PLC Interface

The IND560 terminal provides the ability to directly control its discrete outputs and read its discrete inputs via the (digital) PLC interface options. System integrators should be aware that the IND560 terminal's discrete I/O updates are synchronized with the terminal's interface update rate and not with the PLC I/O scan rate. This may cause a noticeable delay in reading inputs or updating outputs as observed from the PLC to real world signals. Consult the IND560 Terminal Technical Manual for discrete I/O wiring.

4.3. Software Setup

When the IND560 terminal detects the presence of a EtherNet/IP Kit option board, the EtherNet/IP parameters are enabled in a Setup program block at **Communication > PLC > EtherNet/IP**. Figure 4-3 shows the EtherNet/IP setup block.

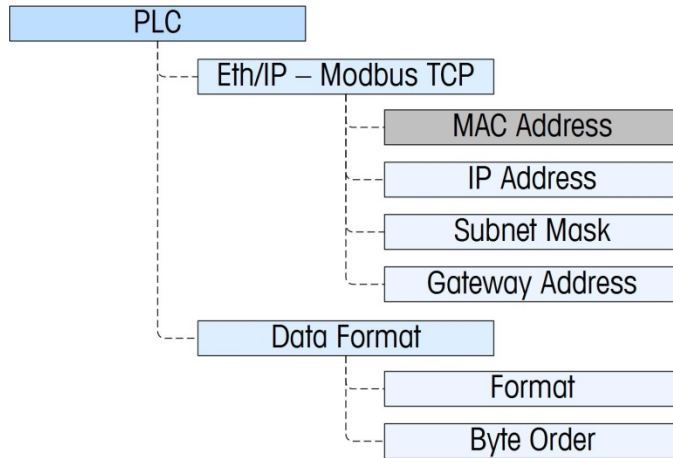

Figure 4-3: EtherNet/IP Setup Block

4.3.1. EtherNet/IP Setup Block

4.3.1.1.1. EtherNet/IP setup:

The EtherNet/IP Setup block in Setup at **Communication > PLC Interface > EtherNet/IP**, allows the EtherNet/IP interface's IP address, subnet mask and gateway address to be specified. The MAC address is displayed, but cannot be modified.

4.3.1.1.2. Data Format setup:

Format

Select the Format (Integer [the default], Divisions, Floating Point or Application). Changing the Format will delete any existing Message Slots.

Byte Order

Available selections are Standard, Byte Swap, Word Swap (default), and Double Word Swap.

Message Slots

Select 1, 2, 3 or 4 slots.

4.4. Troubleshooting

If the IND560 does not communicate with PLC, do the following:

- Check wiring and network termination.
- Confirm that the IND560 settings for data type, size and IP Address assignment match those in the PLC and that each IND560 has a unique address.
- Replace the EtherNet/IP interface kit if the problem persists.
- If the communication kit was changed from another type, like PROFIBUS, DeviceNet or Remote I/O, a master reset of the IND560 should be performed.

4.4.1. Status LEDs

The EtherNet/ IP interface card has four status LEDs indicators to indicate communication and fault status of the card. Figure 4-2 indicates the location of these LEDs, and Figure 4-4 shows the array of the LEDs on the card. Table 4-7 explains the meaning if the indicators.

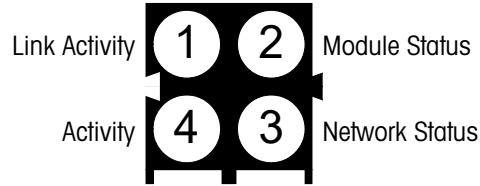

Figure 4-4: EtherNet/IP Status Indicator LEDs

Table 4-7: EtherNet/ IP LEDs Status Indications

LED #	State	Status
1 - Link Activity	Off	No link (or no power)
	Green	Connected to an Ethernet network
2 - Module Status	Off	No power
	Green	Normal operation
	Green, flashing	Stand by, not initialized
	Red	Major fault
	Red, flashing	Minor fault
	Alternating Red/Green	Self test
3 - Network Status	Off	No IP address (or no power)
	Green	EtherNet/IP connection(s) established
	Green, flashing	No EtherNet/IP connections established
	Red	Duplicate IP address detected
	Red, flashing	One or several connections timed out
	Alternating Red/Green	Self test
4 - Activity	Off	No Ethernet activity (or no power)
	Green	Receiving or transmitting Ethernet packet

4.5. EtherNet/IP Option Kit

No spare parts are associated with the EtherNet/IP option kit. The kit CIMF part number is 64058677. Table 4-8 shows what comes in the kit.

Table 4-8: EtherNet/IP Option Kit

Description	Qty.
Installation Instructions	1
PCB package	1
Clamp-on ferrite	1

Description	Qty.
Medium grommet	1
M3 x 8 screws	3
Small metric grip bushing	1
Back plate cover	1

4.6. Programming Examples

The following Figures show sample screen images of ladder logic programming examples for RSLogix 5000 software (version 16).

- Note: The Utilities folder of the documentation CD (part number 71209397) contains complete versions of the examples. These screen images are provided for illustrative purposes only.

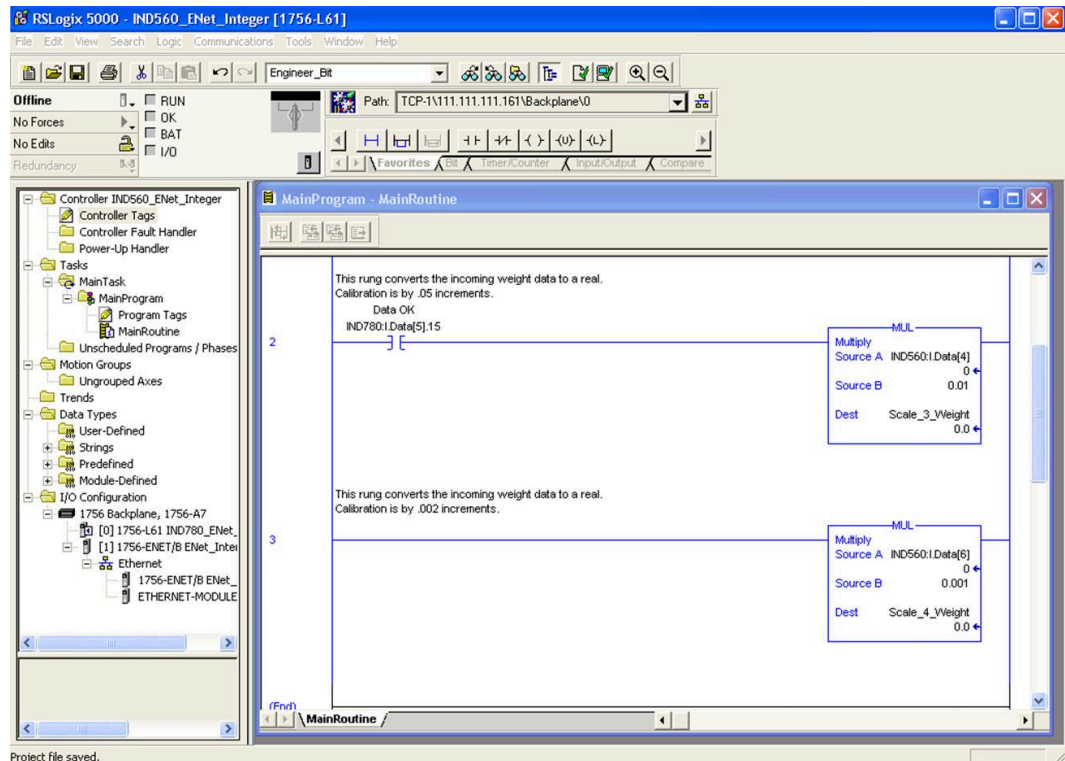

Figure 4-5: Integer Weight Data to Real

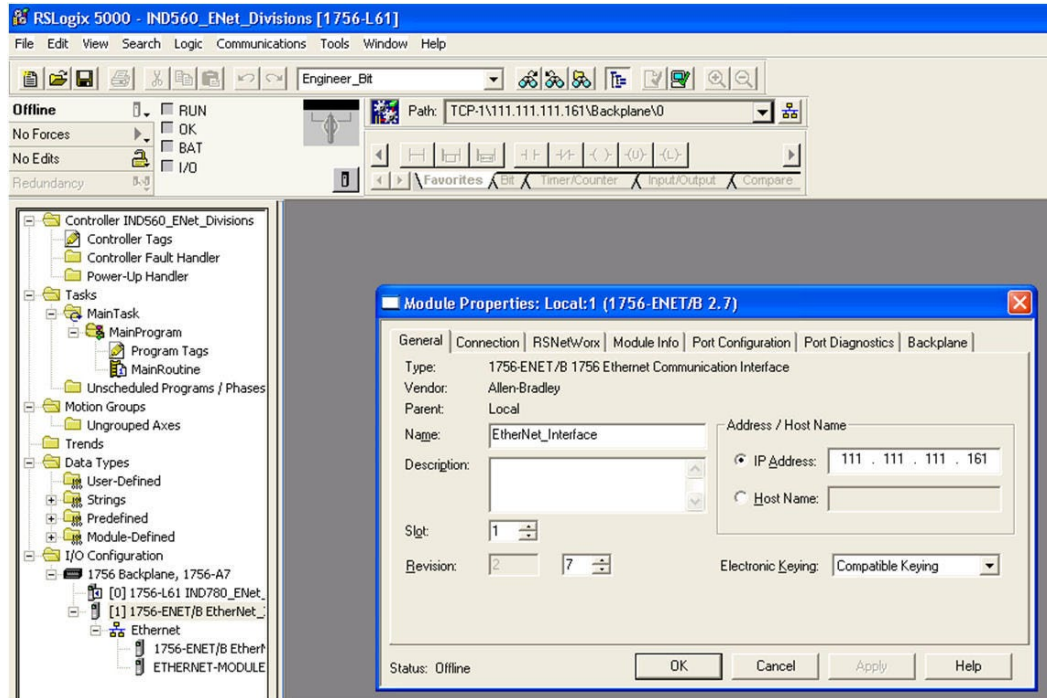

Figure 4-6: EtherNet Bridge in PLC Setup

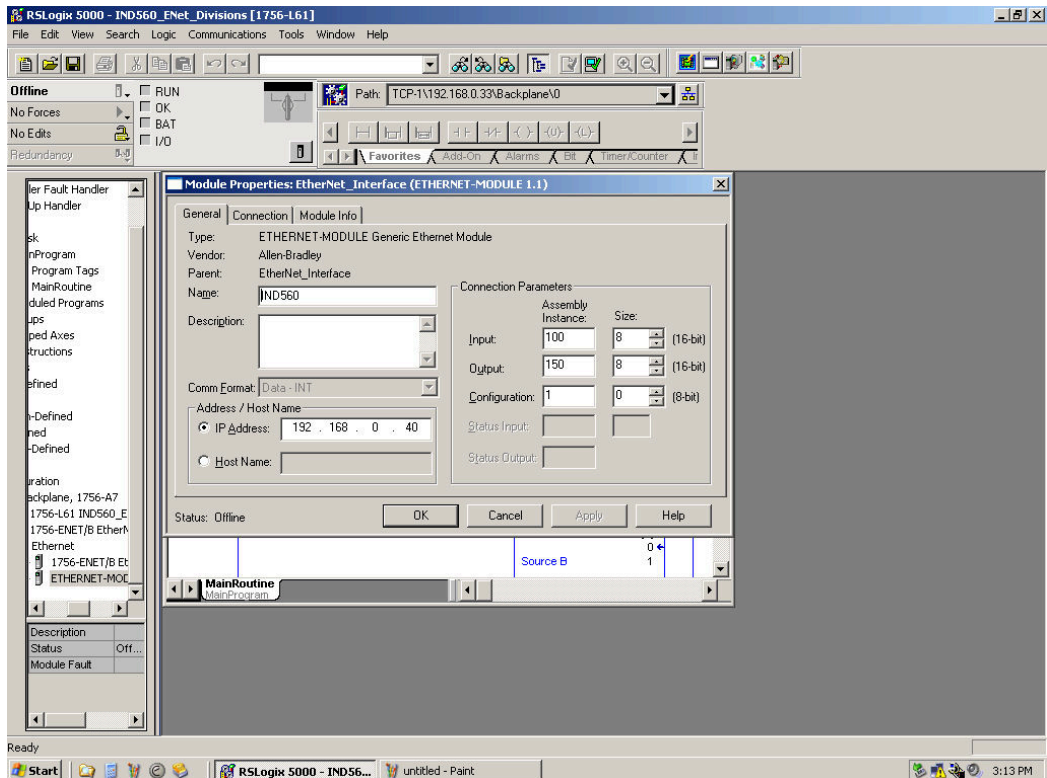

Figure 4-7: EtherNet Module, Divisions

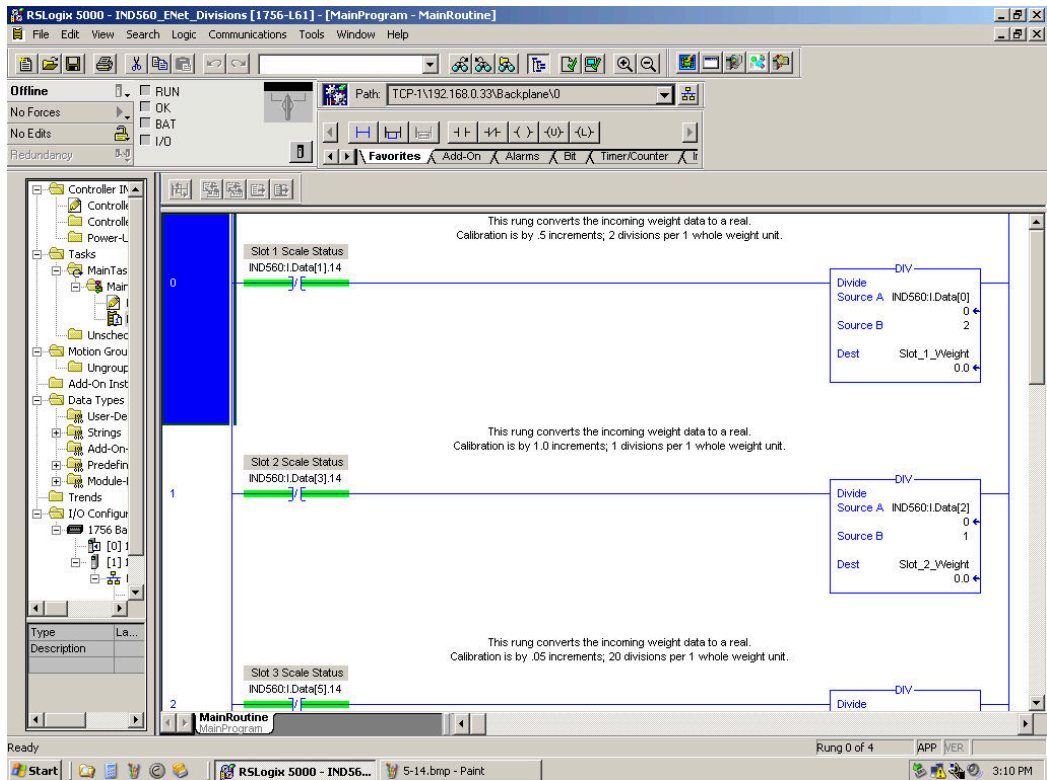

Figure 4-8: Integer Weight Data to Real, Division

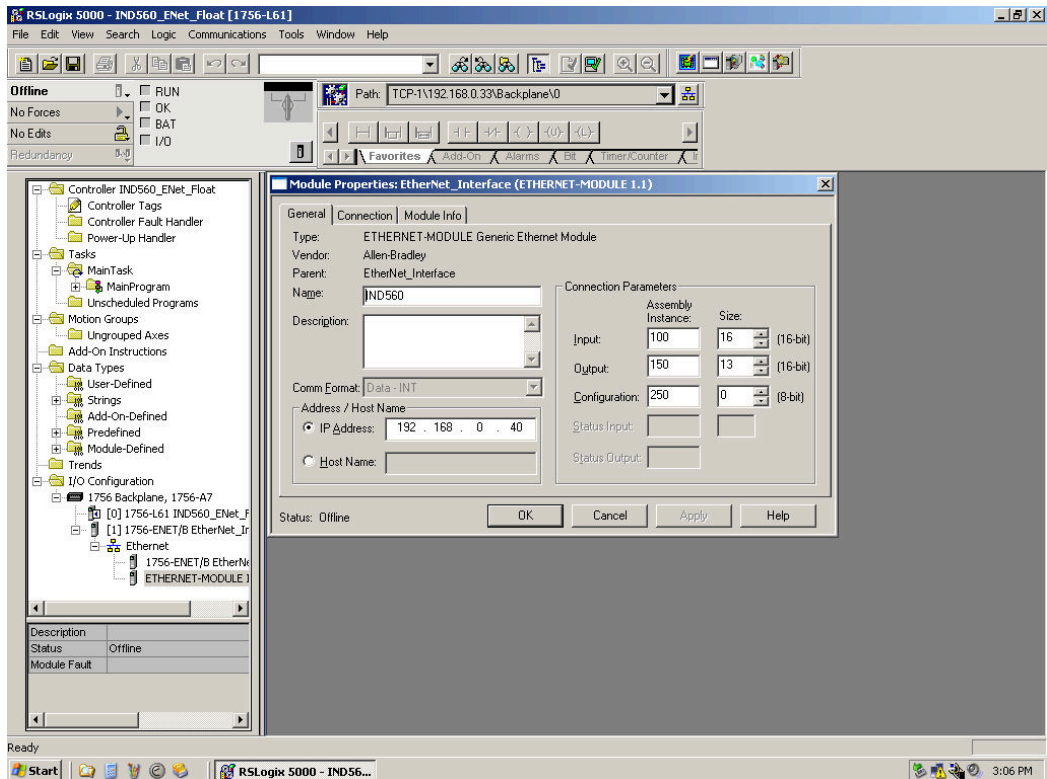

Figure 4-9: EtherNet Module, Floating Point

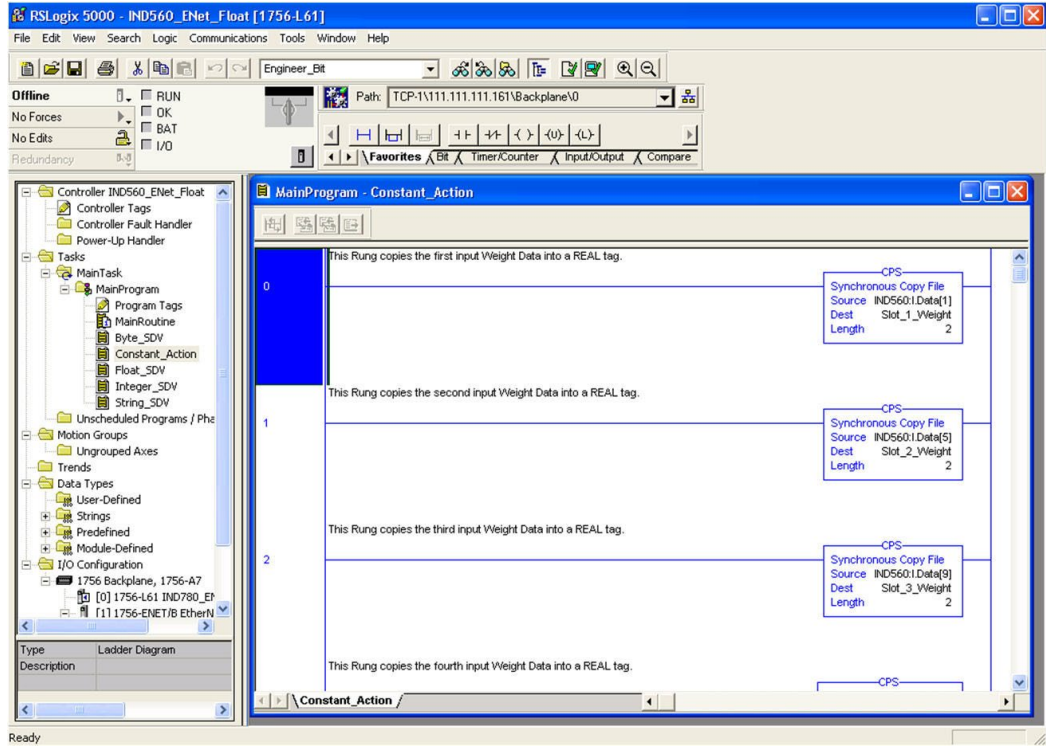

Figure 4-10: Input Weight Data to Real Tag

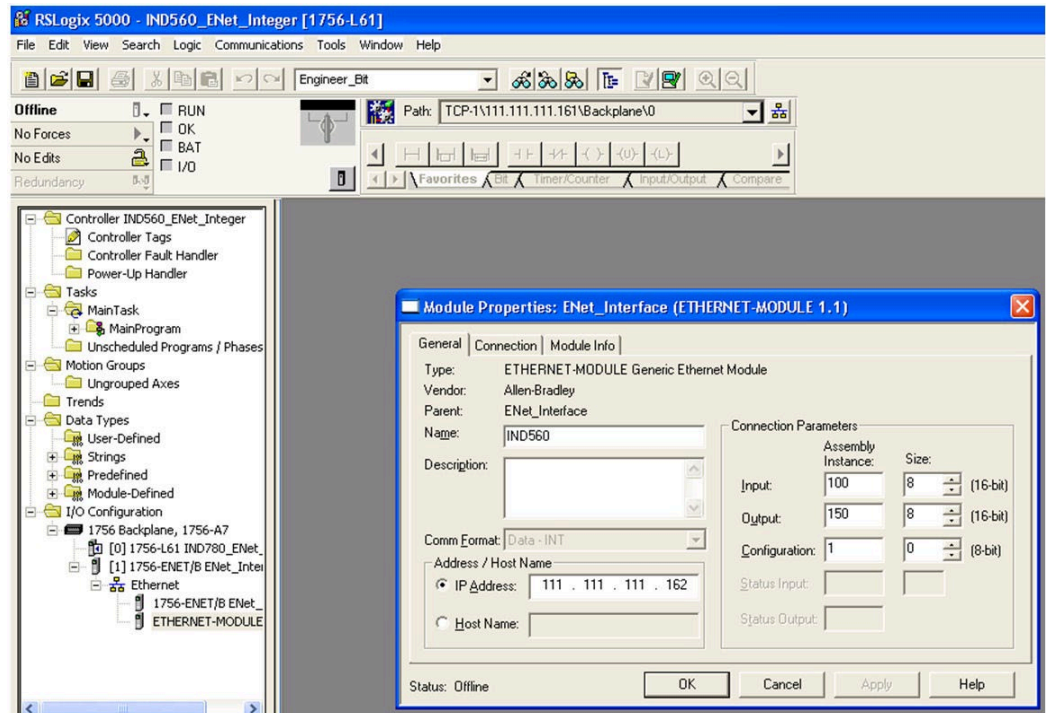

Figure 4-11: EtherNet Module, Integer

5 Modbus TCP Interface

5.1. Preface

- For use with the Modbus TCP protocol, the EtherNet/IP™ option board must be revision 1.32 or higher.

5.2. Overview

Modbus protocol is a messaging structure developed by Modicon in 1979. It is used to establish master-slave/client-server communication between intelligent devices. It is an open standard network protocol, widely used in the industrial manufacturing environment. Modbus can be used in multiple master-slave applications to monitor and program devices; to communicate between intelligent devices and sensors and instruments; and to monitor field devices using PCs and HMIs. Modbus is also an ideal protocol for RTU applications where wireless communication is required.

TCP/IP is an Internet transport protocol of that consists of a set of layered protocols, providing a reliable data transport mechanism between machines. The open Modbus TCP/IP specification was developed in 1999. The ModbusTCP protocol takes the Modbus instruction set and wraps TCP/IP around it.

5.2.1. Specifications

Network Type	Ethernet-TCP/IP based simple Client/Server network.
Topology	Star, tree or line structures; all topologies that can be implemented with standard Ethernet technology, including switched networks, are applicable.
Installation	Standard 10, 100 Mbit/s Ethernet technology based on copper cables, fiber optic or wireless standards can be used. The IND560 Modbus TCP option provides an RJ-45 Ethernet port connection
Speed	10, 100 Mbit/s.
Max. stations	Nearly unlimited.
Network features	Client/Server network based on standard Ethernet technology and TCP/UDP/IP protocols in Layer 3-4.
User Organization	Modbus-IDA user Group.

5.3. Modbus TCP Characteristics

- User-programmable IP addressing
- Capability for bi-directional discrete mode communications (Cyclic Messaging) of weight or display increments, status, and control data between the PLC and the IND560.

5.4. Modbus TCP Board

Figure 5-1 shows a view of the EtherNet/IP Option Board used for Modbus TCP communication. Figure 5-2 indicates the board's port, DIP switches and status lights. Note that the module's address is set in software, and the DIP switches must all be set to OFF.

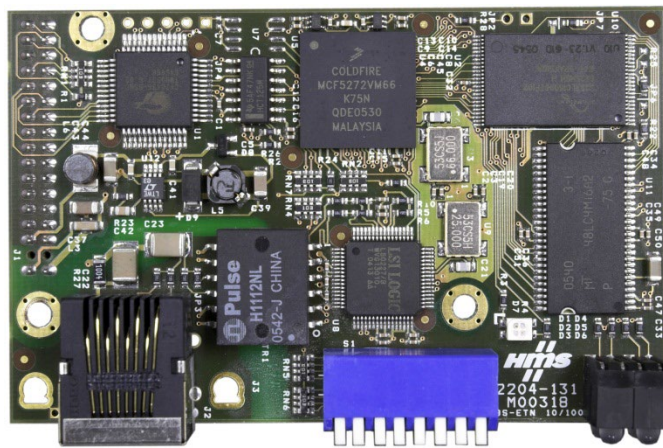

Figure 5-1: EtherNet/IP – Modbus TCP Option Board

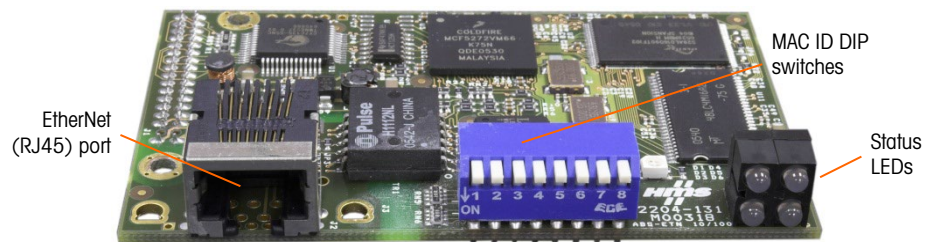

Figure 5-2: EtherNet/IP - Modbus TCP Option Board Components

5.4.1. Communications

The IND560 terminal utilizes component parts to ensure complete compatibility with the Modbus TCP network. An IND560 terminal is recognized as a generic Modbus TCP device by the PLC.

Each Modbus TCP option connected to the network represents a physical IP Address. The connection is made via a RJ-45 connector on the option card (see Figure 5-2).

The wiring between the PLC and the IND560 Modbus TCP connection uses Ethernet twisted pair cable. The cable installation procedures and specification including distance and termination requirements are the same as recommended by Schneider Electric (Modicon) for the Modbus TCP network.

5.4.2. IP Address

Each Modbus TCP interface option represents one physical IP Address. This address is chosen by the system designer, and then programmed into the IND560 terminal and PLC. The IND560 terminal's address is programmed at **Communication > PLC > EtherNet/IP** in the setup menu. The IND560 IP Address entry must be unique for each IND560.

5.4.3. Data Formats

The Modbus TCP Kit option provides discrete data transfer messaging. Discrete data is continuously available. The option has its own logical IP address to send and receive information to and from the PLC. There are three data formats: Integer, Divisions, and Floating Point.

- **Integer** – reports scale weight as a signed 16 bit integer (± 32767).
- **Divisions** – reports scale weight in display divisions (± 32767). The PLC multiplies the reported divisions by the increment size to calculate the weight in display units.
- **Floating Point** – displays weight in floating point data format

Appendix A and B provide detailed information on data formats.

5.5. Data Definition

5.5.1. Data Integrity

The IND560 has specific bits to allow the PLC to confirm that data was received without interruption and that the IND560 is not in an error condition. It is important to monitor these bits. Any PLC code should use them to confirm the integrity of the data received by the IND560. Refer to the data charts in Appendix A and B for specific information regarding the Data OK, Update in Progress and Data Integrity bits and their usage.

5.5.2. Discrete Data

Three formats of discrete data are available with the Modbus TCP Kit option: integer, divisions and floating point. Only one type of data format may be selected and used by the IND560.

The integer and division formats allow bi-directional communication of discrete bit encoded information or 16 bit binary word numerical values. Refer to Appendix A for details.

The floating-point format allows bi-directional communication of discrete bit encoded information and numeric data encoded in IEEE 754, single precision floating point format.

The data format of discrete data will affect the data size required in the configuration of the PLC.

Selection of the appropriate format depends on issues such as the range or capacity of the scale used in the application. The integer format can represent a numerical value up to 32,767. The division format can represent a value up to 32,767 scale divisions or increments. The floating-point format can represent a value encoded in IEEE 754, single precision floating point format.

Floating point is the only data format that includes decimal point information. Integer and division formats ignore decimal points. Accommodation of decimal point location must take place in the PLC logic as needed with these formats.

5.5.2.1.1.

Examples

250 x .01 scale				
IND560 Displays:	0	2.00	51.67	250.00
Format sent:				
Integer	0	200	5167	25000
Division	0	200	5167	25000
Floating Point	0	2.00	51.67	250.00

Any of the formats could be used in this case.

50,000 x 10 scale				
IND560 Displays:	0	200	5160	50000
Format sent:				
Integer	0	200	5160	-(15536)
Division	0	20	516	5000
Floating Point	0	200	5160	50000

The integer format could not be used because it would send a negative or invalid value when the weight exceeds 32,767.

150 x .001 scale				
IND560 Displays:	0	2.100	51.607	150.000
Format sent:				
Integer	0	2100	-(13929)	18928
Division	0	2100	-(13929)	18928
Floating Point	0	2.100	51.607	150.000

The integer format could not be used because it would send a negative or invalid value when the weight exceeds 32,767.

5.5.3. Byte Order

The byte order parameter sets the order in which the data bytes and words will be presented in the PLC data format. Available byte orders are:

- Word Swap - (default) Makes the data format compatible with RSLogix 5000 processors.
- Byte Swap - Makes the integer mode compatible with Modicon Quantum processors.
- Standard – Makes the data format compatible with PLC 5

- Double Word Swap - Makes the data format compatible with the Modicon Quantum PLC for Modbus TCP networks.

Table 5-1 provides examples of the various byte ordering.

- Note: Byte Order was introduced into the IND560 in firmware version 3.xx. Terminals running firmware versions earlier than v3.xx will not see a setting for Byte Order in their setup selections.

Table 5-1: PLC Data Byte Ordering

		Word Swap			Byte Swap			Double Word Swap			Standard		
Terminal Weight Value		1355											
PLC		15	Bit #	0	15	Bit #	0	15	Bit #	0	15	Bit #	0
Integer	Weight value word	0x054B Hex			0x4B05 Hex			0x4B05 Hex			0x054B Hex		
Floating Point	1st Weight value word	0x6000 Hex			0xA944 Hex			0x0060 Hex			0x44A9 Hex		
	2nd Weight value word	0x44A9 Hex			0x0060 Hex			0xA944 Hex			0x6000 Hex		

5.5.4. Register Mapping

The memory of the Modbus TCP Kit option board is mapped as shown in Table 5-2. The read and write areas of memory are offset by 1024. In a Quantum PLC, the PLC would read data from the IND560 starting at 400001 and would write data to the IND560 starting at register 401025.

Table 5-2: Modbus TCP-IP PLC Input and Output data map

Register #	Area	Offset In Area
1	Read Data (from IND560)	0000h...0001h
2		0002h....0003h
3		0004h...0005h
4		0006h...0007h
.....	
1024	Write Data (To IND560)	0000h...0001h
1025		0002h....0003h
1026		0004h...0005h
1027		0006h...0007h
.....	

5.5.5. Message Slots

The IND560 can be configured for up to 4 message slots for discrete data transfer, in Integer, Divisions and Floating Point Data Formats. Each message slot is assigned to an internal local or remote scale. The integer and division formats provide (two 16-bit words of input and two 16-bit words of output data) per Message Slot. Each Message Slot's first input word provides scale weight data and the input weight data may be selected by the PLC using the Message Slot's second output word bit 0, bit 1 and bit 2. The following two Tables provide input and output usage information.

- 4000, 40001 and 400001 are PLC processor memory-dependent. Refer to the PLC documentation for I/O mapping.

Table 5-3: Modbus TCP PLC Input Data and Data Usage (Integer and Division)

PLC Input Bytes	Register Address	Usage
0	400001	Message Slot 1 Weight Data
1		Message Slot 1 Weight Data
2	400002	Message Slot 1 Scale Status
3		Message Slot 1 Scale Status
4	400003	Message Slot 2 Weight Data
5		Message Slot 2 Weight Data
6	400004	Message Slot 2 Scale Status
7		Message Slot 2 Scale Status
8	400005	Message Slot 3 Weight Data
9		Message Slot 3 Weight Data
10	400006	Message Slot 3 Scale Status
11		Message Slot 3 Scale Status
12	400007	Message Slot 4 Weight Data
13		Message Slot 4 Weight Data
14	400008	Message Slot 4 Scale Status
15		Message Slot 4 Scale Status

Table 5-4: Modbus TCP PLC Output Words and Word Usage (Integer and Division)

PLC Output Bytes	Register Address	Usage
0	401025	Message Slot 1 Weight Data
1		Message Slot 1 Weight Data
2	401026	Message Slot 1 Scale Command
3		Message Slot 1 Scale Command
4	401027	Message Slot 2 Weight Data
5		Message Slot 2 Weight Data
6	401028	Message Slot 2 Scale Command
7		Message Slot 2 Scale Command
8	401029	Message Slot 3 Weight Data
9		Message Slot 3 Weight Data
10	401030	Message Slot 3 Scale Command
11		Message Slot 3 Scale Command
12	401031	Message Slot 4 Weight Data
13		Message Slot 4 Weight Data
14	401032	Message Slot 4 Scale Command
15		Message Slot 4 Scale Command

The floating point format provides four 16-bit words of input data and three 16-bit words of output data per Message Slot. See Table 5-5 and Table 5-6 for details.

The number of Message Slots is set up in **Communication > PLC > Data Format** setup menu.

Table 5-5: Modbus TCP PLC Floating Point Input Words

Register Address	Bits 0 – 7	Bits 8 – 15
400001	Message Slot 1: Reserved	Message Slot 1: Command Response*
400002	Message Slot 1: Floating Point data	Message Slot 1: Floating Point data
400003	Message Slot 1: Floating Point data	Message Slot 1: Floating Point data
400004	Message Slot 1: Scale Status	Message Slot 1: Scale Status
400005	Message Slot 2: Reserved	Message Slot 2: Command Response
400006	Message Slot 2: Floating Point data	Message Slot 2: Floating Point data
400007	Message Slot 2: Floating Point data	Message Slot 2: Floating Point data
400008	Message Slot 2: Scale Status	Message Slot 2: Scale Status
400009	Message Slot 3: Reserved	Message Slot 3: Command Response
400010	Message Slot 3: Floating Point data	Message Slot 3: Floating Point data
400011	Message Slot 3: Floating Point data	Message Slot 3: Floating Point data
400012	Message Slot 3: Scale Status	Message Slot 3: Scale Status
400013	Message Slot 4: Reserved	Message Slot 4: Command Response
400014	Message Slot 4: Floating Point data	Message Slot 4: Floating Point data
400015	Message Slot 4: Floating Point data	Message Slot 4: Floating Point data
400016	Message Slot 4: Scale Status	Message Slot 4: Scale Status

*See Message Slot Table Appendix B for details

Table 5-6: Modbus TCP PLC Floating Point Output Words

PLC Output Bytes	Register Address	Usage
0	401025	Reserved
1		Reserved
2	401026	Message Slot 1: Command
3		Message Slot 1: Command
4	401027	Message Slot 1: Floating Point data
5		Message Slot 1: Floating Point data
6	401028	Message Slot 1: Floating Point data
7		Message Slot 1: Floating Point data
8	401029	Message Slot 2: Command
9		Message Slot 2: Command
10	401030	Message Slot 2: Floating Point data
11		Message Slot 2: Floating Point data
12	401031	Message Slot 2: Floating Point data
13		Message Slot 2: Floating Point data
14	401032	Message Slot 3: Command
15		Message Slot 3: Command
16	401033	Message Slot 3: Floating Point data
17		Message Slot 3: Floating Point data
18	401034	Message Slot 3: Floating Point data
19		Message Slot 3: Floating Point data
20	401035	Message Slot 4: Command
21		Message Slot 4: Command
22	401036	Message Slot 4: Floating Point data
23		Message Slot 4: Floating Point data
24	401037	Message Slot 4: Floating Point data
25		Message Slot 4: Floating Point data

5.5.6. Integer and Division

When one of these formats is selected, the IND560 will have two 16-bit words for input data and two 16-bit words for output data in each Message Slot. The PLC's input data will contain one 16-bit word for the scale's weight information and one 16-bit word for bit encoded status information for each Message Slot. The IND560 will send specific weight data to the PLC input data based on the data it receives from the PLC's output data. The PLC's output words consist of one 16-bit integer value, which may be used to download a tare or target, and one 16-bit word for bit encoded command information.

Appendix A provides detailed information on the integer and division data formats.

5.5.7. Floating Point

5.5.7.1. Operational Overview

The terminal uses integer commands from the PLC to select the floating point weight output data. The terminal recognizes a command when it sees a new value in the scale's command word. If the

command has an associated floating point value (for example: loading a target value), it must be loaded into the floating point value words before the command is issued. Once the terminal recognizes a command, it acknowledges the command by setting a new value in the command acknowledge bits of the scale's command response word. It also tells the PLC what floating point value is being sent (via the floating point input indicator bits of the command response word). The PLC waits until it receives the command acknowledgment from the terminal before sending another command.

The terminal has two types of values that it can report to the PLC: real-time and static. When the PLC requests a real-time value, the terminal acknowledges the command from the PLC once but sends and updates the value at every interface update cycle. If the PLC requests a static value, the terminal acknowledges the command from the PLC once and updates the value once. The terminal will continue to send this value until it receives a new command from the PLC. Gross weight and net weight are examples of real-time data. Tare weight, target, fine feed, and tolerance values are examples of static data.

The terminal can send a rotation of up to nine different real-time values for each scale. The PLC sends commands to the terminal to add a value to the rotation. Once the rotation is established, the PLC must instruct the terminal to begin its rotation automatically, or the PLC may control the pace of rotation by instructing the terminal to advance to the next value. If the terminal is asked to automatically alternate its output data, it will switch to the next value in its rotation at the next interface update cycle. (The interface update cycle has an update rate of up to 20 Hz or 58 milliseconds.)

The PLC may control the rotation by sending alternate report next field commands (1 and 2). When the PLC changes to the next command, the terminal switches to the next value in the rotation. The terminal stores the rotation in its shared data so the rotation does not have to be re-initialized after each power cycle. When the PLC does not set up an input rotation, the default input rotation consists of gross weight only. See the floating-point rotation examples in Appendix B for additional information. The method of handling string and floating point data may vary between different PLCs. The IND560 provides floating point data in the byte order entered in the Data Format setup.

Appendix B provides detailed information on the floating point data format. The byte order shown follows the convention of the Modicon Quantum platform. Note that this is Double Word Swapped.

5.5.7.2. Floating Point Data Format and Compatibility

In Floating Point Message mode, the PLC and IND560 terminal exchange weight, target, and tare data in single-precision floating point format. The IEEE Standard for Binary Floating-Point Arithmetic, ANSI/IEEE Standard 754-1985, specifies the format for single-precision floating point numbers. It is a 32-bit number that has a 1-bit sign, an 8-bit signed exponent, and a 23-bit mantissa. The 8-bit signed exponent provides scaling of weight and rate data. The 23-bit mantissa allows representation of 8 million unique counts.

Although the single-precision floating point number provides greater numerical precision and flexibility than integer weight representations, it has limitations. The weight representation may not be exact, particularly for the extended-resolution weight fields for high-precision bases.

Some PLCs require special integrity checking to communicate floating point numbers. There are two data integrity bits that the IND560 uses to maintain data integrity when communicating with the PLC. One bit is in the beginning word of the data; the second is in the ending byte of the data for a scale slot. The PLC program must verify that both data integrity bits have the same polarity for the

data in the scale slot to be valid. There is a possibility that the PLC program will see several consecutive invalid reads when the terminal is freely sending weigh updates to the PLC, if the PLC program detects this condition, it should send a new command to the terminal.

The method of handling string and floating point data varies between PLCs platforms. The IND560 provides floating point data in the word order set up by the user.

5.5.8. Controlling the Discrete I/O Using a PLC Interface

The IND560 terminal provides the ability to directly control some of its discrete outputs and read some of its discrete inputs via the (digital) PLC interface options. System integrators should be aware that the terminal's discrete I/O updates are synchronized with the terminal's interface update cycle rate and not with the PLC I/O scan rate. This may cause a noticeable delay in reading inputs or updating outputs as observed from the PLC to real world signals. Consult the IND560 Terminal Technical Manual for discrete I/O wiring. Also note that the outputs must be unassigned in the IND560 terminal setup.

5.6. Software Setup

The IND560 terminal automatically detects the presence of a Modbus TCP Kit option board if one is installed. When the option is detected, the IND560 terminal enables the Modbus TCP parameters in a program block at **Communications > PLC Interface > Ethernet/IP**. Figure 5-3 shows the Modbus TCP setup block.

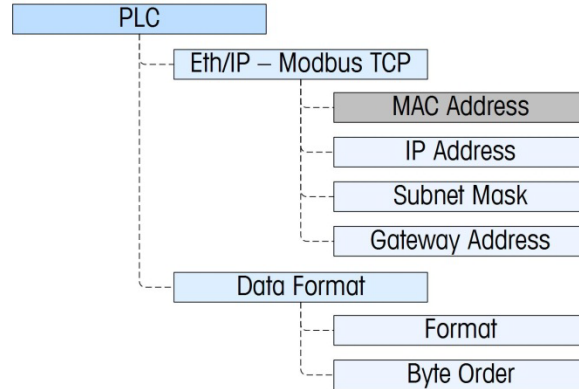

Figure 5-3: The Modbus TCP Setup Block

5.6.1. Modbus TCP Setup Block

5.6.1.1. Modbus TCP setup

Setup for Modbus TCP is the same setup block used for EtherNet/IP setup. The Modbus setup, found at **Communication > PLC > Ethernet/IP**, allows the Modbus TCP interface's IP address, subnet mask and gateway address to be specified. The MAC address is displayed, but cannot be modified.

5.6.1.2. Data Format setup

5.6.1.2.1. Format

Select the Format (Integer [the default], Divisions, Floating Point or Application). Changing the Format will delete any existing Message Slots.

- **Integer** – reports scale weight as a signed 16 bit integer (± 32767).
- **Divisions** – reports scale weight in display divisions (± 32767). The PLC multiplies the reported divisions by the increment size to calculate the weight in display units.
- **Floating Point** – displays weight in floating point data format

5.6.1.2.2. Byte Order

Available selections are Standard, Byte Swap, Word Swap (default), and Double Word Swap.

Message Slots

Select 1, 2, 3 or 4 slots.

5.7. Troubleshooting

If the IND560 does not communicate with PLC, do the following:

- Check wiring and network termination.
- Confirm that the IND560 settings for data type and IP Address assignment match those in the PLC and that each IND560 has a unique address.
- Replace the EtherNet / IP – Modbus TCP interface kit if the problem persists.
- If the communication kit was changed from another type, like PROFIBUS, ControlNet or Remote I/O, a master reset of the IND560 must be performed.

5.7.1. Status LEDs

The EtherNet/ IP – Modbus TCP interface card has four status LEDs indicators to indicate communication and fault status of the card. Figure 5-2 indicates the location of these LEDs, and Figure 5-4 shows the array of the LEDs on the card. Table 5-7 explains the meaning

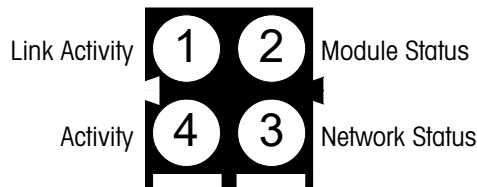

Figure 5-4:– Modbus TCP Board Status LED Array

Table 5-7: EtherNet / IP LEDs Status Indications

LED #	State	Status
1 - Link Activity	Off	No link (or no power)
	Green	Connected to an Ethernet network

LED #	State	Status
2 - Module Status	Off	No power
	Green (1 Hz flash)	IP address not set via switch
	Red (1 Hz flash)	Invalid MAC address (internal error)
	Red (2 Hz flash)	Failed to load Ethernet configuration
	Red (4 Hz flash)	Fatal internal error
	Red	Duplicate IP address detected
3 - Network Status	This LED indicates the number of established Modbus/TCP connections to the terminal. The number of established connections is equal to the number of "blinks" or "flashes" on this LED.	
4 - Activity	Off	No Ethernet activity (or no power)
	Green, flashing	Flashes green each time a packet is received or transmitted

5.8. Modbus TCP Option Kit

No spare parts are associated with the Modbus TCP option kit. The kit CIMF part number is 64058677. Table 5-8 shows what comes in the kit.

Table 5-8: Modbus TCP Option Kit

Description	Qty.
Installation Instructions	1
PCB Package	1
Clamp-on ferrite	1
M3 x 8 screws	3

5.9. Modbus TCP Configuration Example

This demo was set up using Concept Version 2.6 XL, SR1, b (Figure 5-5).

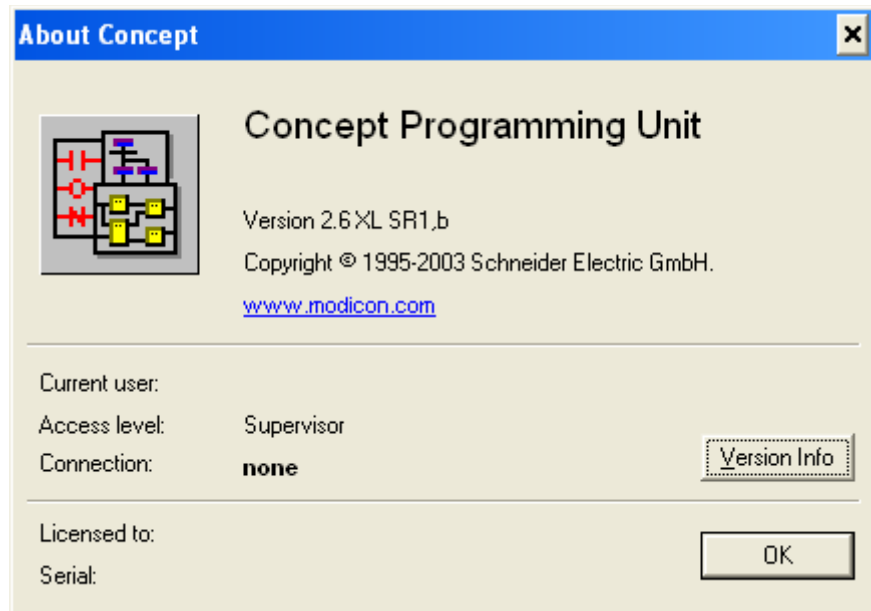

Figure 5-5: Concept Programming Unit Welcome Screen

Open a project by accessing the file menu and selecting OPEN, then selecting the project. In this example, the project is named MT_INT.PRJ (Figure 5-6).

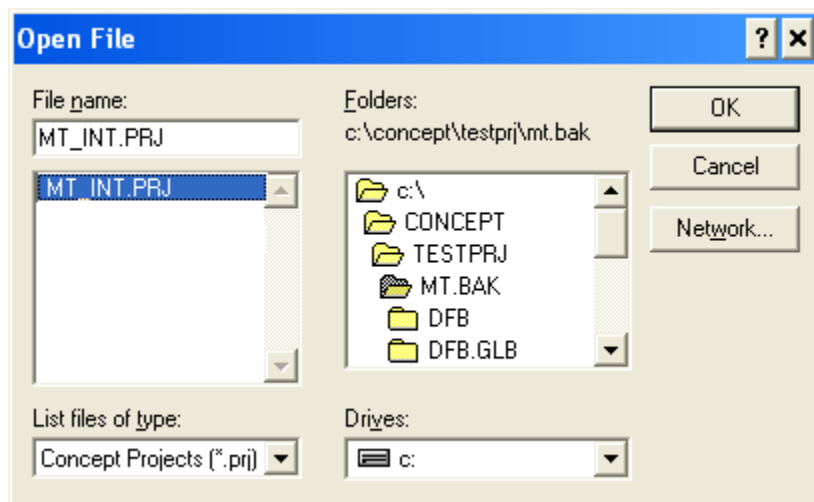



Figure 5-6: Project Selection Dialog

Once the project is open, the project browser should appear; if it does not appear, click on  to display it.

Next the Network card must be configured. Double click on your project in the project browser. In this example, click on the blue highlighted (Figure 5-7) item to open the PLC Configuration window.

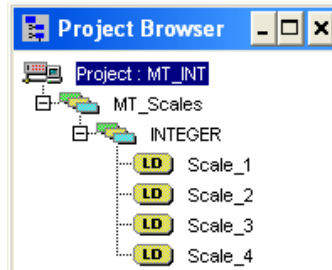

Figure 5-7: Project Viewed in Project Browser

The PLC Configuration window (Figure 5-8) will open.

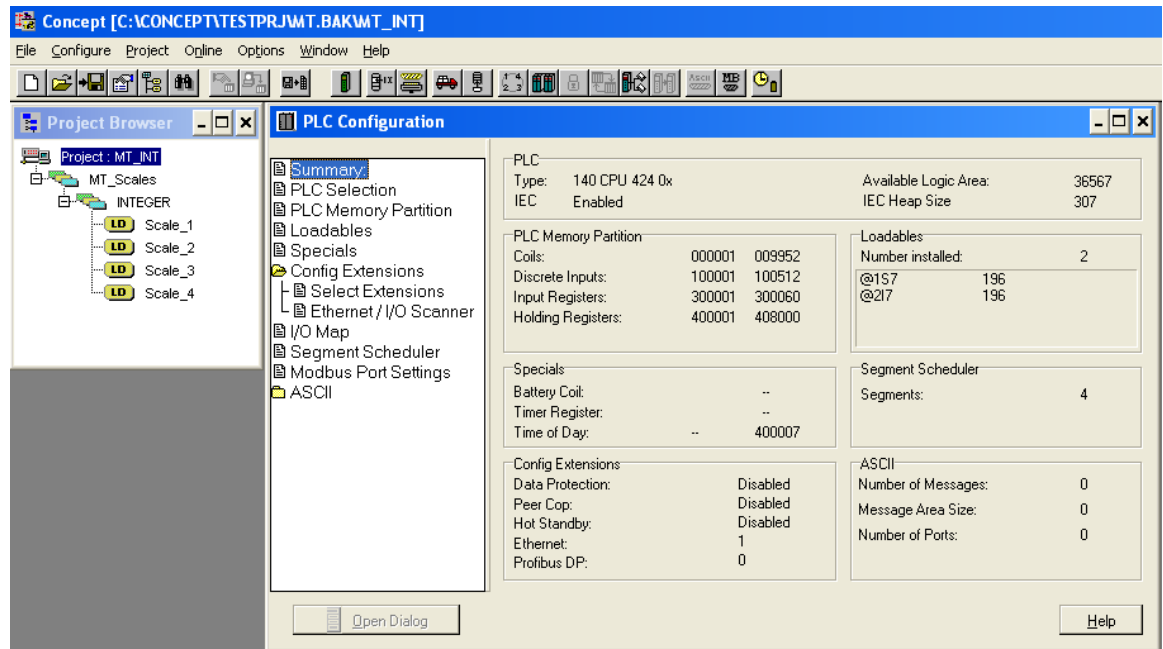

Figure 5-8: PLC Configuration Window

Click on the Config Extensions Folder in the center pane, above. The branch will expand to show Ethernet / I/O Scanner. Double click on the Ethernet / I/O Scanner to bring up the details of the Ethernet card (Figure 5-9).

Here, the IP addresses must be configured – the PLC's, that of the IND560 with which it communicates. The data communicated to and from the IND560 is also configured in this window.

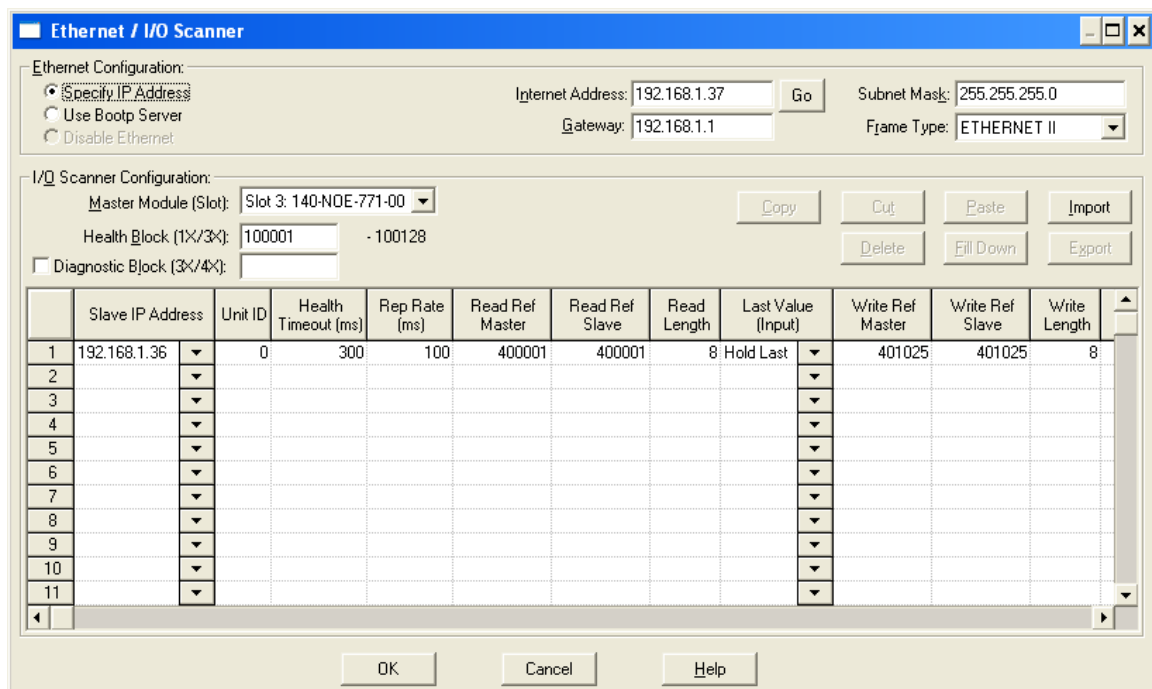
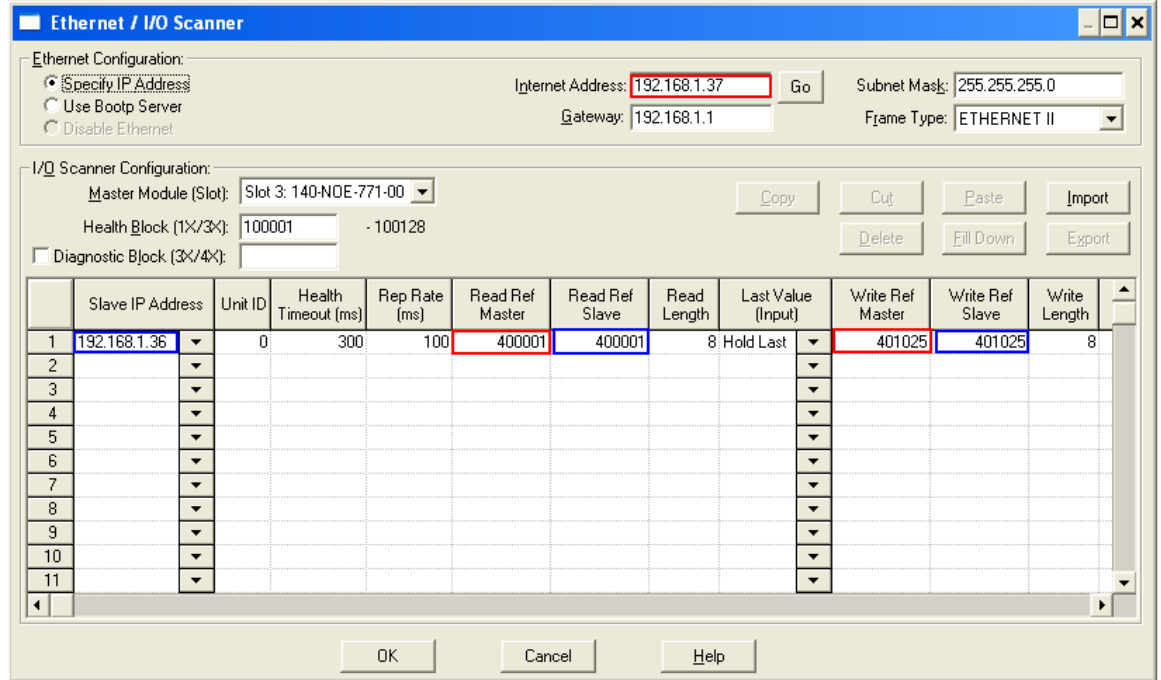

Figure 5-9: Ethernet / I/O Scanner Window

For a more detailed description of each column in the configuration window, click on the Help button (at lower right in Figure 5-9). The following elements must be configured:

- Slave IP Address: IP Address of the IND560 terminal's Modbus TCP interface. This value is configured in the IND560 Setup tree at **Communication > PLC Interface > EtherNet/IP**.
- Unit ID: This value is typically 0
- Health Timeout:
- Rep Rate:
- Read Ref Master: The start of PLC registers to which the IND560's information is written. This address ALWAYS is 400001
- Read Ref Slave: The start of IND560 register where the scale data is stored. This address can be any value 4XXXXX PLC address.
 - * NOTE, data in the Read Ref Slave is read and then stored in the Read Ref Master.
- Read Length & Write Length: This is determined by the IND560 settings, and is determined by # of scales, Mode of operation etc. In our example we are using 4 slots in INTEGER Mode. In the IND560 we are reading 16 bytes and writing 16 bytes. When configuring the PLC each 4XXXX register address word consists of 2 bytes of information. This gives a total of 16 bytes / 2 bytes per word, or 8 for Read Length and 8 for Write Length.

Both the PLC and the IND560 IP address and address settings must be configured – refer to Figure 5-10. The Ethernet card used on the configuration shown is the 140-NOE-771-00



192.168.1.37 PLC
400001 IND560 401025 IND780

Figure 5-10: PLC and IND560 Values for Ethernet / I/O Scanner

Examples of how to configure the Modicon Ethernet I/O scanner for various scale configurations are provided below.

5.9.1. Integer and Division Mode Configuration

The IND560 Configured for 4 slots in either integer or division mode. 8 Words are Read into the PLC and 8 words are written to the IND560. Table 5-9 indicates the values for each scale.

	Slave IP Address	Unit ID	Health Timeout (ms)	Rep Rate (ms)	Read Ref Master	Read Ref Slave	Read Length	Last Value (Input)	Write Ref Master	Write Ref Slave	Write Length
1	192.168.1.36	0	300	100	400001	400001	8	Hold Last	401025	401025	8

Figure 5-11: Integer or Division Mode Configuration

Table 5-9: Configuration of Integer or Division Mode

Description	Slot / Scale*	Address in IND560	Format
Read by PLC from 560:			
Weight Data	Slot 1	400001	Int
Status Data	Slot 1	400002	Int
Weight Data	Slot 2	400003	Int
Status Data	Slot 2	400004	Int
Weight Data	Slot 3	400005	Int
Status Data	Slot 3	400006	Int

Description	Slot / Scale*	Address in IND560	Format
Read by PLC from 560:			
Weight Data	Slot 4	400007	Int
Status Data	Slot 4	400008	Int
The PLC will write to:			
Data Value to be written	Slot 1	401025	Int
Command Word	Slot 1	401026	Int
Data Value to be written	Slot 2	401027	Int
Command Word	Slot 2	401028	Int
Data Value to be written	Slot 3	401029	Int
Command Word	Slot 3	401030	Int
Data Value to be written	Slot 4	401031	Int
Command Word	Slot 4	401032	Int

* 4001, 40001, 400001 are PLC Memory Dependent.

5.9.2. Floating Point Mode Configuration

The IND560 Configured for 4 slots in Floating Point mode FP. 16 Words are Read into the PLC and 13 words are written to the IND560. Table 5-10 indicates the values for each scale.

	Slave IP Address	Unit ID	Health Timeout (ms)	Rep Rate (ms)	Read Ref Master	Read Ref Slave	Read Length	Last Value (Input)	Write Ref Master	Write Ref Slave	Write Length
1	192.168.1.36	0	300	100	400001	400001	16 Hold Last		401025	401025	13

Figure 5-12: FLP Mode Configuration

Table 5-10: Configuration Floating Point Mode

Description	Slot / Scale*	Address in IND560	Format
Read by PLC from 560:			
Weight Data	Slot 1	400002-400003	Float
Command Ack Register	Slot 1	400001	Int
Status Register	Slot 1	400004	Int
Weight Data	Slot 2	400006-400007	Float
Command Ack Register	Slot 2	400005	Int
Status Register	Slot 2	400008	Int
Weight Data	Slot 3	400010-400011	Float
Command Ack Register	Slot 3	400009	Int
Status Register	Slot 3	400012	Int

Description	Slot / Scale*	Address in IND560	Format
Read by PLC from 560:			
Weight Data	Slot 4	400014-400015	Float
Command Ack Register	Slot 4	400013	Int
Status Data	Slot 4	400016	Int
The PLC will write to:			
Reserved	Slot 1	401025	Int
Command Word	Slot 1	401026	Int
Data Value to be Written	Slot 1	401027-401028	Float
Command Word	Slot 2	401029	Int
Data Value to be Written	Slot 2	401030-401031	Float
Command Word	Slot 3	401032	Int
Data Value to be Written	Slot 3	401033-401034	Float
Command Word	Slot 4	401035	Int
Data Value to be Written	Slot 4	401036-401037	Float

* Note that any scale data can be configured to correspond with any slot number. 4001, 40001, 400001 PLC Memory Dependent.

5.9.3. Integer Logic Examples

2 Words of Data are associated with a scale when in integer mode.

- Weight Data for scale 1 is stored in the IND560 in register 400001.
- Status Data for this weight and the IND560 is in register 400002.

5.9.3.1. Read Logic

The 400001 weight data can be read directly by the PLC. However, to understand the 400002 Status data fully some basic logic is needed to break the data Word into Bits.

In concept the use of an INT_TO_WORD instruction will first read the integer value from the IND560 in a form that can be broken into bits. Then once the data is in a word format, a WORD_TO_BIT instruction will complete the process of extracting the individual bits. Figure 5-13 and Figure 5-14 show an example of logic that can be used to read the status word.

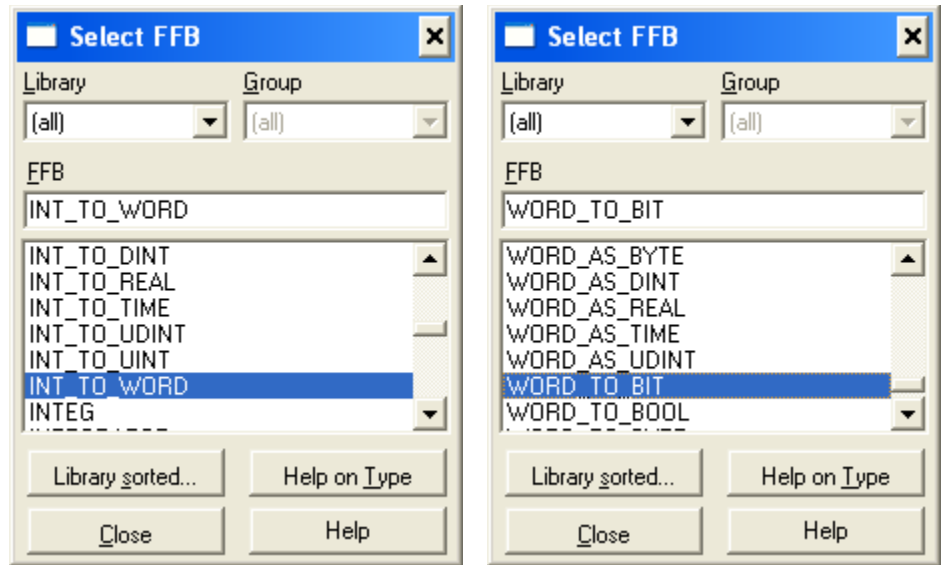

Figure 5-13: Selecting Integer-to-Word (left) and Word-to-Bit (right) Conversions

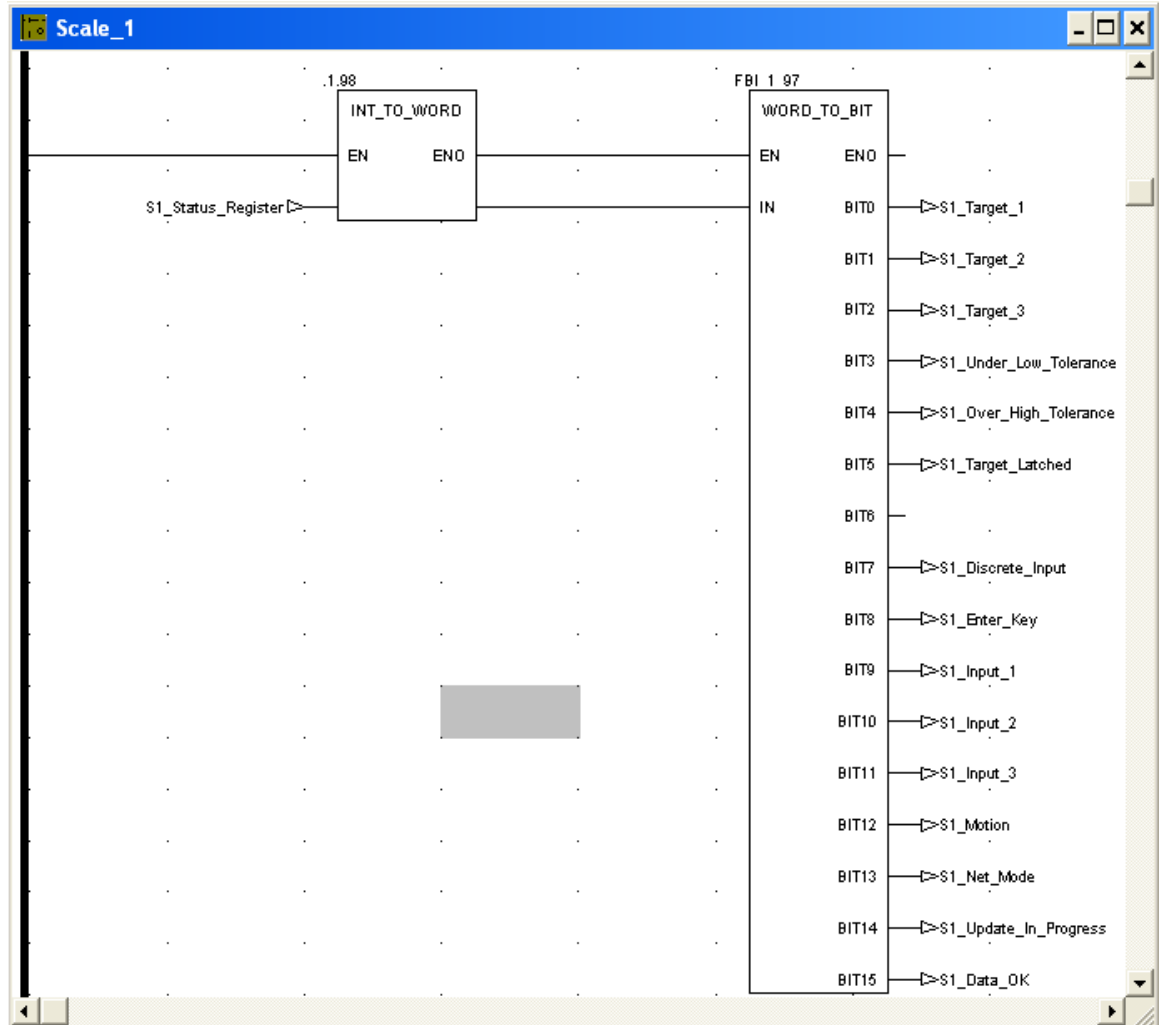

Figure 5-14: Integer-to-Word and Word-to-Bit Logic

5.9.3.2.

Write Logic

The 401025 Data Value can be written directly by the PLC. However, to utilize the 401026 command word fully some basic logic is needed to convert the command Bits into a data Word.

In concept, the use of a BIT_TO_WORD instruction will first get the command bits into a WORD value. Next the use of a WORD_TO_INT instruction will complete the process of packing the individual command bits into an integer format that can be written to the IND560. Figure 5-15 shows an example of logic that can be used control the command word.

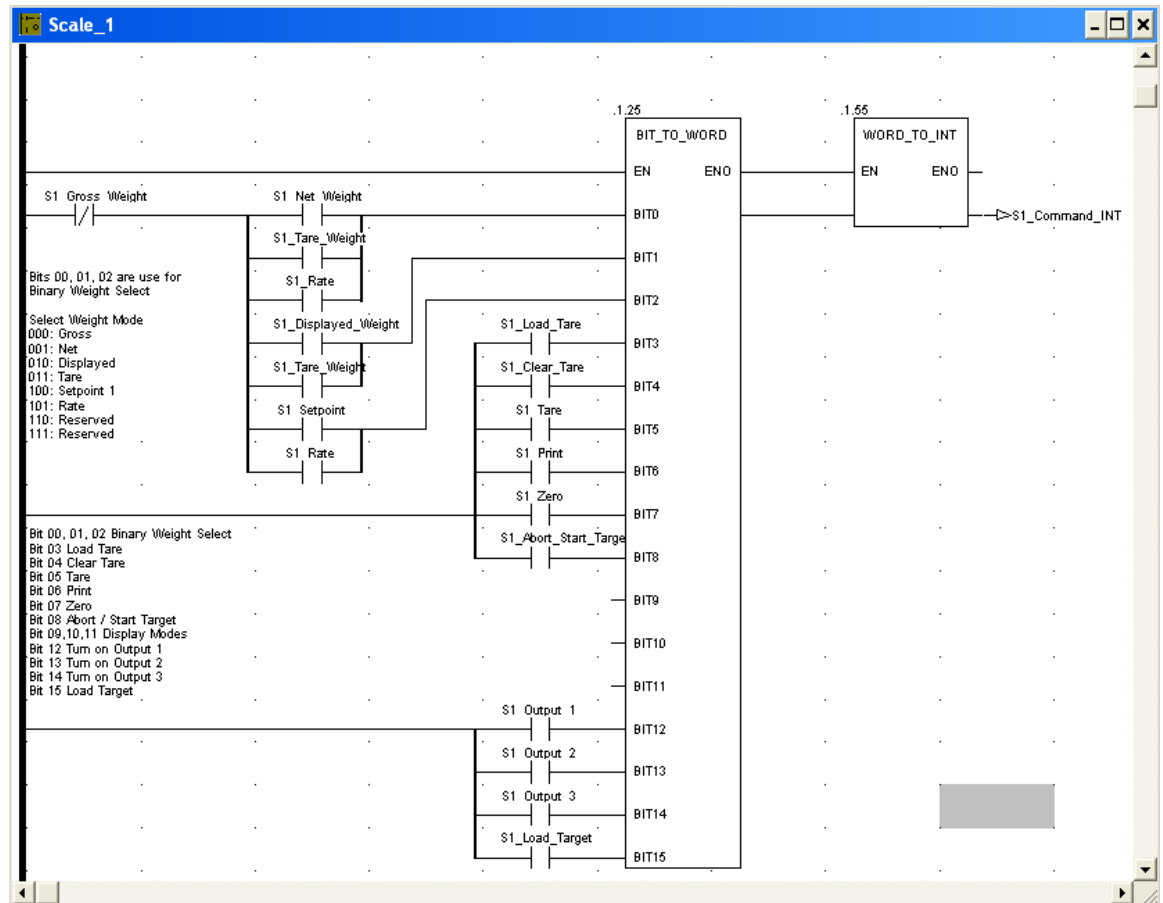

Figure 5-15: Bit to Word and Word to Integer Logic

6 PROFIBUS Option

6.1. Overview

The PROFIBUS option card enables the IND560 terminal to communicate to a PROFIBUS DP master according to DIN 19 245. It consists of an IND560 terminal backplane-compatible module and software that resides in the terminal, which implements the data exchange.

The PROFIBUS option card interfaces to programmable logic controllers (PLCs) such as Texas Instruments 505 series, Siemens S5 series, and Siemens S7 series PLCs. The PROFIBUS appears as a block of I/O on the PROFIBUS network. The size and mapping of the I/O depends on the setup of the PROFIBUS card at the IND560.

The data mapped within the I/O block is defined as Discrete or Shared Data Variables. Discrete data can be set as Integer, Division, or Floating Point.

Discrete data is sent in groups defined as message blocks. The number of message blocks (1 to 4) is setup within the IND560. While the format of each message block is the same, the data received and displayed within a message block is dependant on the commands within the block.

The Texas Instruments (TI) 505 PLCs interface to the PROFIBUS via an I/O processor called a Field Interface Module (FIM). The FIM bus master recognizes a fixed set of PROFIBUS slave devices, all of which are viewed by it as some sort of remote I/O rack. On power up, the FIM queries each PROFIBUS slave node to determine which of the recognized types a device might be and configures itself accordingly. The PROFIBUS option appears to the FIM to be a small ET200U I/O rack.

The Siemens S5-115 series PLC also interfaces to the PROFIBUS using an I/O processor, an IM-308. This device must be locally programmed with the terminal interface type files. Newer Siemens S7 PLCs have the PROFIBUS option on their main controller card.

The type of option board used depends on the IND560 enclosure in which it is to be used. The two boards differ in the orientation of their connectors. Figure 6-1 shows the harsh version of the option

board, Figure 6-2 the panel mount version. Both connectors are active on the harsh version of the option board.

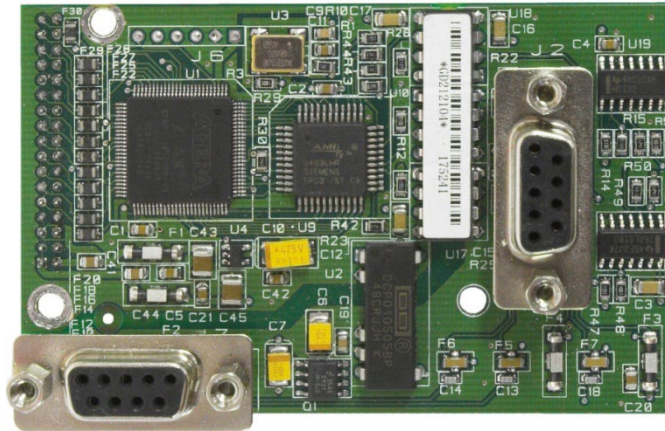

Figure 6-1: PROFIBUS Kit Option Board, Harsh Enclosure Version

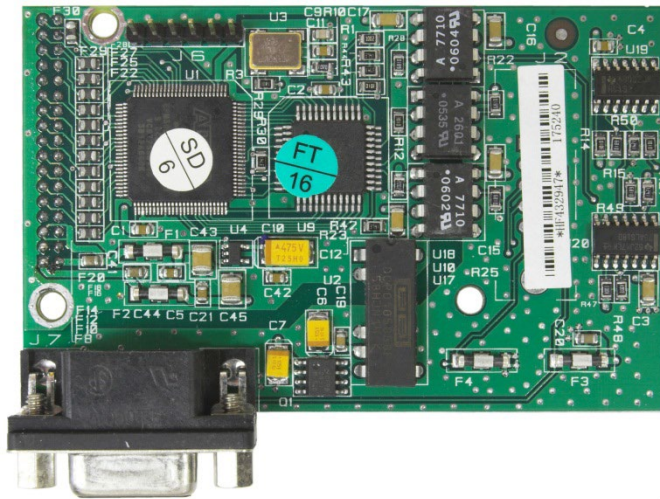

Figure 6-2: PROFIBUS Kit Option Board, Panel Mount Version

6.1.1. Communications

PROFIBUS is based on a variety of existing national and international standards. The protocol architecture is based on the Open Systems Interconnection (OSI) reference model in accordance with the international standard ISO 7498.

The IND560 terminal supports the PROFIBUS-DP which is designed for high-speed data transfer at the sensor actuator level. (DP means Distributed Peripherals.) At this level, controllers such as PLCs exchange data via a fast serial link with their distributed peripherals. The data exchange with these distributed devices is mainly cyclic. The central controller (master) reads the input information from the slaves and sends the output information back to the slaves. It is important that the bus cycle time is shorter than the program cycle time of the controller, which is approximately 10 ms in most applications. The following is a summary of the technical features of the PROFIBUS-DP communications protocol:

- 6.1.1.1. Transmission Technique
- PROFIBUS DIN 19 245 Part 1
- EIA RS 485 twisted pair cable or fiber optic
 - 9.6 kbit/s up to 12 Mbit/s, max distance 200 m at 1.5 Mbit/s extendible with repeaters
 - 12 megabaud maximum rate
- 6.1.1.2. Medium Access
- Hybrid medium-access protocol according to DIN 19 245 Part 1
- Mono-Master or Multi-Master systems supported
 - Master and Slave Devices, max 126 stations possible
- 6.1.1.3. Communications
- Peer-to-Peer (user data transfer) or Multicast (synchronization)
- Cyclic Master-Slave user data transfer and acyclic Master-Master data transfer
- 6.1.1.4. Operation Modes
- Operate: Cyclic transfer of input and output data
- Clear: Inputs are read and outputs are cleared
 - Stop: Only master-master functions are possible
- 6.1.1.5. Synchronization
- Enables synchronization of the inputs and/or outputs of all DP-Slaves
- Sync-Mode: Outputs are synchronized
 - Freeze-Mode: Inputs are synchronized
- 6.1.1.6. Functionality
- Cyclic user data transfer between DP-Master(s) and DP-Slave(s)
 - Activation or deactivation of individual DP-Slaves
 - Checking of the configuration of the DP-Slaves
 - Powerful diagnosis mechanisms, three hierarchical levels of the diagnosis
 - Synchronization of inputs and/or outputs
 - Address assignment for the DP-Slaves over the bus
 - Configuration of the DP-Master (DPM1) over the bus
 - Maximum 246 byte input and output data per DP-Slave, typical 32 byte
- 6.1.1.7. Security and Protection Mechanisms
- All messages are transmitted with Hamming Distance HD=4

- Watch-Dog Timer at the DP-Slaves
- Access protection for the inputs/outputs at the DP-Slaves
- Data transfer monitoring with configurable timer interval at the DP-Master (DPM1)

6.1.1.8. Device-Types

- DP-Master Class 2 (DPM2) for example, programming/configuration device
- DP-Master Class 1 (DPM1) for example, central controller like PLC, CNC, or RC
- DP-Slave for example, Input/Output device with binary or analog inputs/outputs, drives

6.1.1.9. Cabling and Installation

- Coupling or uncoupling of stations without affecting other stations
- Proven and easy to handle two conductor transmission technique

6.1.2. Node/Rack Address

Each IND560 PROFIBUS option card represents one physical node. The node address is chosen by the system designer and then programmed into the IND560 and PLC. The IND560's node address is programmed in Setup at **Communication > PLC**. The node address and number of input and output words used to communicate between the terminal and the PLC are programmed into the PLC by using its PROFIBUS network configuration software and the IND560's PROFIBUS GSD-type files.

The IND560 setup allows selection of the logical rack (node) address, data format (Integer/Floating Point/Divisions), the number of message slots assigned to the node, and the option of sending and receiving Shared Data. The number of input and output words required and the mapping of the I/O data is dependent on these selections.

The IND560 PROFIBUS GSD has a block of I/O defined for each of the 16 possible IND560 PROFIBUS combinations. The IND560 terminal will determine the number of input and output words needed for the number of configured message slots and chosen data format. The PLC must be configured for the same amount of space.

6.1.3. Data Formats

The terminal's PROFIBUS option card has two types of data exchanges: discrete data and shared data. The locations for each of these types of data are predefined by the IND560.

Each message slot selected to pass data through the terminal's PROFIBUS option has its own assigned input and output words for continuous information to and from the PLC. Shared data access is only available when the Setup/ Communications/PLC/PROFIBUS Share Data option is Enabled. This data is used to pass information that cannot be sent in the discrete data because of size or process speed limitations. It uses additional input and output word space. The length of shared data value and data type is dependent on the type of shared data field requested. In no case does it exceed 10 words (20 bytes).

6.2. Data Integrity

The terminal has specific bits to allow the PLC to confirm that the data was received without interrupt, and the scale is not in an error condition. It is important to monitor these bits. The PLC code must use them to confirm the integrity of the data received for the scale. Refer to the detailed data charts in Appendix A and B for specific information regarding the Data OK, Update in Progress, and Data Integrity bits and their usage.

6.3. Discrete Data

There are three formats of discrete data available with the PROFIBUS option card: integer, division, and floating point.

- **Integer** – (default) Reports scale weight as a signed 16 bit integer.
- **Divisions** – Reports scale weight in display divisions. The PLC multiplies the reported divisions by the increment size to calculate the weight in display units.
- **Floating Point** – Displays weight in floating point data format.

Appendix A and B provide detailed information on data formats.

The discrete data format affects the input/output word space required per message slot and the amount of input/output words used by the PROFIBUS option card.

Integer and division formats require two 16-bit words of input and two 16-bit words of output data per message slot. One slot uses two 16-bit words of input and two 16-bit words of output; two slots use four 16-bit words of input and four 16-bit words of output; three slots use six 16-bit words of input and six 16-bit words of output; and four slots use eight 16-bit words of input and eight 16-bit words of output.

The floating-point format requires more space per messages slot because floating point data uses two 16-bit words of data to represent the numeric data alone. The floating-point format requires four 16-bit words of input and four 16-bit words of output data per slot. Four scales using the floating-point format would use 16 words of input and 16 words of output data.

Selection of the appropriate format depends on different issues. The range or capacity of the scale used in the application should be considered. The integer format can represent a numerical value of up to 32,767; the division format can represent a numerical value of up to 32,767 divisions (or increments); and, the floating-point format can represent a numerical value encoded in IEEE 754, single precision floating-point format.

Floating point is the only format that includes decimal point information as a part of its data. All other formats ignore decimal points in their data. Accommodation of decimal point location must take place in the PLC logic, when it is needed with these formats.

6.3.1. Examples

250 x .01 scale					50,000 x 10 scale				
IND570 Displays:	0	2.00	51.67	250.00	IND570 Displays:	0	200	5160	50000
Format sent:					Format sent:				
Integer	0	200	5167	25000	Integer	0	200	5160	-(xxxxx)
Division	0	200	5167	25000	Division	0	20	516	5000
Floating Point	0	2.00	51.67	250.00	Floating Point	0	200	5160	50000

Any of the formats could be used in this case.

The integer format could not be used because it would send a negative or invalid value once the weight exceeded 32,760.

150 x .001 scale				
IND570 Displays:	0	2.100	51.607	150.000
Format sent:				
Integer	0	2100	-(xxxxx)	-(xxxxx)
Division	0	2100	-(xxxxx)	-(xxxxx)
Floating Point	0	2.100	51.607	150.000

The integer and division formats could not be used because they would send a negative value once the weight exceeded 32.767.

Please refer to Appendix A and Appendix B for each format's detailed description of data available to determine which is most suitable.

6.3.2. Byte Order

The byte order parameter sets the order in which the data bytes and words will be presented in the PLC data format. Available Byte Orders are:

- Word Swap - (default) Makes the data format compatible with RSLogix 5000 processors.
- Byte Swap - Makes the data format compatible with S7 Profibus.
- Standard - Makes the data format compatible with PLC 5.
- Double Word Swap - Makes the data format compatible with the Modicon Quantum PLC.

Table 6-1 provides examples of the various byte ordering.

Table 6-1: PLC Data Byte Ordering

		Word Swap			Byte Swap			Double Word Swap			Standard		
Terminal Weight Value		1355											
PLC		15	Bit #	0	15	Bit #	0	15	Bit #	0	15	Bit #	0
Integer	Weight value word	0x054B Hex			0x4B05 Hex			0x4B05 Hex			0x054B Hex		
Floating Point	1st Weight value word	0x6000 Hex			0xA944 Hex			0x0060 Hex			0x44A9 Hex		

		Word Swap			Byte Swap			Double Word Swap			Standard		
Terminal Weight Value		1355											
PLC		15	Bit #	0	15	Bit #	0	15	Bit #	0	15	Bit #	0
	2nd Weight value word	0x44A9 Hex			0x0060 Hex			0xA944 Hex			0x6000 Hex		

6.4. Floating Point

6.4.1. Operational Overview

For a general account of Floating Point operation, please refer to Appendix B, Floating Point Format.

6.4.2. Floating Point Data Format and Compatibility

In Floating Point Message mode, the PLC and terminal exchange weight, target, and tare data in single-precision floating point format. The IEEE Standard for Binary Floating-Point Arithmetic, ANSI/IEEE Standard 754-1985, specifies the format for single-precision floating point numbers. It is a 32-bit number that has a 1-bit sign, an 8-bit signed exponent, and a 23-bit mantissa. The 8-bit signed exponent provides scaling of weight data. The 23-bit mantissa allows representation of 8 million unique counts.

Although the single-precision floating point number provides greater numerical precision and flexibility than integer weight representations, it has limitations. The weight representation may not be exact, particularly for the extended-resolution weight fields for high-precision bases.

There are two data integrity bits that the IND560 uses to maintain data integrity when communicating to the PLC. One bit is in the beginning byte of the data; the second is in the ending byte of the data for a scale slot. The PLC program must verify that both data integrity bits have the same polarity for the data in the scale slot to be valid. There is a possibility that the PLC program will see several consecutive invalid reads when the IND560 is freely sending weight updates. If the PLC program detects this condition, it should send a new command to the IND560.

6.4.3. Floating Point Numbers

The Simatic TI505 PLCs support the IEEE Standard floating point numbers. According the Simatic TI505 Programming Reference Manual real numbers are stored in the single-precision 32-bit format, according to ANSI/IEEE Standard 754-1985, in the range 5.42101070 E-20 to 9.22337177 E18.

Siemens S5 PLCs do not support inherently the IEEE-format floating point numbers. S5 PLCs do support floating point numbers in their own unique format. You can implement a software "function block" in the S5 PLC that converts between the S5 floating point numbers and the IEEE Standard floating point numbers.

The Siemens S7 PLCs support the IEEE Standard floating point numbers.

6.5. Shared Data

6.5.1. Operational Overview

PROFIBUS PLCs can access the terminal's Shared Data. Since the PROFIBUS communications supports up to 244-byte messages at speeds typically in the range of 1.5 to 12 megahertz, there is no need for two separate modes of communication, as there is for Allen-Bradley and its block transfer. PROFIBUS PLCs can read IND560 Shared Data variables and write new values to IND560 Shared Data variables. For PROFIBUS, the PLC output data has additional fields for accessing Shared Data.

The PLC must specify the Shared Data command and variable name in the PLC output message. If the command is a write command, then the PLC output message must also contain the write field value. The maximum length of the value is 20 bytes.

When the Shared Data command is a read command, the PLC input message will have a read field containing the data from the Shared Data variable specified in the output message. The maximum length of the data reported in the read field is 20 bytes.

The Shared Data variables are self-typing. The IND560 terminal determines the type of any valid data field in the message from the variable's name and definition in Shared Data. The terminal will not allow string data to be written in a floating point variable or vice versa.

6.5.2. Shared Data Input

The input information for the shared data consists of two sections: the shared data status and the shared data read field value (if requested by the shared data output command). The shared data status information is a word that contains an integer value. This integer value represents one of the following status values:

- 0 Null status
- 1 Command completed successfully
- 2 Invalid shared data name
- 3 Invalid shared data command
- 4 Cannot write because field is write-protected (legal for trade)

The shared data read field value contains the value of the shared data variable specified in the shared data output (from the PLC to the terminal). It is only present when the command from the shared data output requests read shared data. This value is self-typing; for example, it could be a floating point number or a string variable. The length is determined by the variable selected but will not exceed 20 bytes. See the tables following the Shared Data Output for a list of possible variables and their contents.

6.5.3. Shared Data Output

The output information for the shared data consists of four sections: the shared data command, the shared data name, the shared data variable name, and the shared data write value (if required by the shared data output command). The shared data command information is a word that contains an integer value. This integer value represents one of the following status values:

- 0 Null command
- 1 Read shared data
- 2 Write shared data

The terminal processes a shared data command "on demand" by the PLC. When a new value is placed in the shared data command word, the terminal will perform the command issued. The terminal does not provide "real time" information to the PLC; it supplies a "snapshot" of the data not an automatic update of new values of the same shared data command. Instead, the PLC must request the information again by setting a new value in the shared data command word.

To do successive reads, for example, the PLC must alternate between a "null" command and a "read" command in the shared data command word. For the most efficient processing, the PLC should set up the terminal name, the variable name, and the write value (if any) while it is setting the "null" command. Once that is completed, the PLC can then set the shared data command to "read" or "write".

Refer to the IND560 Shared Data Reference for a complete listing of Shared Data Fields.

6.6. Discrete Data I/O Space Usage Comparison

The following tables show a comparison of the integer, division, floating point, and shared data formats' input and output data usage.

Table 6-2 shows a comparison between the integer data formats and the floating point format of the input data. The input data is from the IND560 terminal to the PLC, with node configured beginning at address "0" and data format configured for four Message Slots.

Table 6-2: Input Data Comparison

Address Word #	Integer, Division	Floating Point
IW:0 or WX:0	1st Slot (weight)	1st Slot command response
IW:1 or WX:1	1st Slot (status)	1st Slot floating point
IW:2 or WX:2	2nd Slot (weight)	Value
IW:3 or WX:3	2nd Slot (status)	1st Slot status
IW:4 or WX:4	3rd Slot (weight)	2 nd Slot command response*
IW:5 or WX:5	3rd Slot (status)	2nd Slot floating point*
IW:6 or WX:6	4th Slot (weight)	Value
IW:7 or WX:7	4th Slot (status)	2nd Scale status*
IW:8 or WX:8	Null	3 rd Slot command response
IW:9 or WX:9	Shared Data Access Status	3 rd Slot floating point
IW:10 or WX:10	Shared Data Read Field Value**	Value
IW:11 or WX:11	Shared Data Read Field Value**	3 rd Slot status
IW:12 or WX:12	Shared Data Read Field Value**	4 th Slot command response

Address Word #	Integer, Division	Floating Point
IW:13 or WX:13	Shared Data Read Field Value**	4 th Slot floating point
IW:14 or WX:14	Shared Data Read Field Value**	Value
IW:15 or WX:15	Shared Data Read Field Value**	4 th Slot status
IW:16 or WX:16	Shared Data Read Field Value**	Shared Data Access Status
IW:17 or WX:17	Shared Data Read Field Value**	Shared Data Read Field Value**
IW:18 or WX:18	Shared Data Read Field Value**	Shared Data Read Field Value**
IW:19 or WX:19	Shared Data Read Field Value**	Shared Data Read Field Value**
IW:20 or WX:20		Shared Data Read Field Value**
~		~
IW:26 or WX:26		Shared Data Read Field Value**

** The length of shared data value is dependent on the type of shared data field requested. In no case does it exceed 10 words (20 bytes).

Table 6-3 shows a comparison between the integer data formats and the floating point format of the output data from the PLC to the IND560 terminal, with node configured beginning at address 0 and data format configured for four Message Slots.

Table 6-3: Output Data Comparison

Address Word #	Integer or Division	Floating Point
QW:0 or WY:0	1 st Slot (load value)	Reserved
QW:1 or WY:1	1 st Slot (command)	1 st Slot command
QW:2 or WY:2	2 nd Slot (load value)	1 st Slot Floating point
QW:3 or WY:3	2 nd Slot (command)	load value
QW:4 or WY:4	3 rd Slot (load value)	2 nd Slot command*
QW:5 or WY:5	3 rd Slot (command)	2 nd Slot Floating point
QW:6 or WY:6	4 th Slot (load value)	load value*
QW:7 or WY:7	4 th Slot (command)	3 rd Slot command
QW:8 or WY:8	Shared Data Command (‘1’ = Read, ‘2’ = Write)	3 rd Slot Floating point
QW:9 or WY:9	Null	load value
QW:10 or WY:10	Shared Data Variable Name First two characters of SDV Name ex: ‘w1’ of ‘w10101’	4 th Slot command
QW:11 or WY:11	Shared Data Variable Name Middle two characters of SDV Name ex: ‘01’ of ‘w10101’	4 th Slot Floating point

Address Word #	Integer or Division	Floating Point
QW:12 or WY:12	Shared Data Variable Name Last two characters of SDV Name ex: '01' of 'wt0101'	load value
QW:13 or WY:13	Shared Data Write Value**	Shared Data Command ('1' = Read, '2' = Write)
QW:14 or WY:14	Shared Data Write Value**	Null
QW:15 or WY:15	Shared Data Write Value**	Shared Data Variable Name First two characters of SDV Name ex: 'wt' of 'wt0101'
QW:16 or WY:16	Shared Data Write Value**	Shared Data Variable Name Middle two characters of SDV Name ex: '01' of 'wt0101'
QW:17 or WY:17	Shared Data Write Value**	Shared Data Variable Name Last two characters of SDV Name ex: '01' of 'wt0101'
QW:18 or WY:18	Shared Data Write Value**	Shared Data Write Value**
QW:19 or WY:19	Shared Data Write Value**	Shared Data Write Value**
QW:20 or WY:20	Shared Data Write Value**	Shared Data Write Value**
QW:21 or WY:21	Shared Data Write Value**	Shared Data Write Value**
QW:22 or WY:22	Shared Data Write Value**	Shared Data Write Value**
		Shared Data Write Value**
~		~
QW:27 or WY:27		Shared Data Write Value**

** The length of shared data value is dependent on the type of shared data field requested. In no case does it exceed 10 words (20 bytes).

6.7. IND560 PROFIBUS Message Mapping

6.7.1. Division/Integer–Shared Data Disabled

Message Slots = 1 Total Size = 2 Words

Message Slots = 2 Total Size = 4 Words

Message Slots = 3 Total Size = 6 Words

Message Slots = 4 Total Size = 8 Words

6.7.1.1. Request (PLC to IND560)

Word 0 – Word 1: Slot 1 (1st Message Slot)

Word 2 – Word 3: Slot 2 (2nd Message Slot)

Word 4 – Word 5: Slot 3 (3rd Message Slot)

Word 6 – Word 7: Slot 4 (4th Message Slot)

6.7.1.2. Response (IND560 to PLC)

Word 0 – Word 1: Slot 1 (1st Message Slot)

Word 2 – Word 3: Slot 2 (2nd Message Slot)

Word 4 – Word 5: Slot 3 (3rd Message Slot)

Word 6 – Word 7: Slot 4 (4th Message Slot)

6.7.2. Division/Integer–Shared Data Enabled

Message Slot = 1 total Size = 17 Words

6.7.2.1. Request (PLC to IND560)

Word 0 – Word 1: Message Slot 1

Word 2 Request Command: 1 - Read SDV / 2 - Write SDV

Word 3: NULL

Word 4 – Word 6: SDV name : example wf0101

Word 7 – Word 16: SDV write value

6.7.2.2. Response (IND560 to PLC)

Word 0 – Word 1: Message Slot 1

Word 2: NULL

Word 3: SD access status

Word 4 – Word 13: SD read value

6.7.3. Division/Integer–Shared Data Enabled

Message Slot = 2 Total Size = 19 words

6.7.3.1. Request (PLC to IND560)

Word 0 – Word 1: Message Slot 1

Word 2 – Word 3: Message Slot 2

Word 4 Request Command: 1 - Read SDV / 2 - Write SDV

Word 5: NULL

Word 6 – Word 8: SDV name : example wf0101

Word 9 – Word 18: SDV write value

6.7.3.2. Response (IND560 to PLC)

Word 0 – Word 1: Slot 1

Word 2 – Word 3: Slot 2

Word 4: NULL

Word 5: SD access status

Word 6 – Word 15: SD read value

6.7.4. Division/Integer–Shared Data Enabled

Message Slot = 3 Total Size = 21 Words

6.7.4.1. Request (PLC to IND560)

Word 0 – Word 1: Message Slot 1

Word 2 – Word 3: Message Slot 2

Word 4 – Word 5: Message Slot 3

Word 6 Request Command: 1 - Read SDV / 2 - Write SDV

Word 7: NULL

Word 8 – Word 10: SDV name : example wt0101

Word 11 – Word 20: SDV write value

6.7.4.2. Response (IND560 to PLC)

Word 0 – Word 1: Message Slot 1

Word 2 – Word 3: Message Slot 2

Word 4 – Word 5: Message Slot 3

Word 6: NULL

Word 7: SD access status

Word 8 – word 17: SD read value

6.7.5. Division/Integer–Shared Data Enabled

Message Slot = 4 Total Size = 23 Words

6.7.5.1. Request (PLC to IND560)

Word 0 – Word 1: Message Slot 1

Word 2 – Word 3: Message Slot 2

Word 4 – Word 5: Message Slot 3

Word 6 – Word 7: Message Slot 4

Word 8 Request Command: 1 - Read SDV / 2 - Write SDV

Word 9: NULL

Word 10 – Word 12: SDV name : example wt0101

Word 13 – Word 22: SDV write value

- 6.7.5.2. Response (IND560 to PLC)
- Word 0 – Word 1: Slot 1
 - Word 2 – Word 3: Slot 2
 - Word 4 – Word 5: Slot 3
 - Word 6 – Word 7: Slot 4
 - Word 8: NULL
 - Word 9: SD access status
 - Word 10 – word 19 : SD read value

6.7.6. Floating Point Shared Data Disabled

- Message Slots = 1 Total Size = 4
- Message Slots = 2 Total Size = 8
- Message Slots = 3 Total Size = 12
- Message Slots = 4 Total Size = 16

- 6.7.6.1. Request (PLC to IND560)
- Word 0: Reserved
 - Word 1 – Word 3: Message Slots 1
 - Word 4 – Word 6: Message Slots 2
 - Word 7 – Word 9: Message Slots 3
 - Word 10 – Word 12: Message Slots 4

- 6.7.6.2. Response (IND560 to PLC)
- Word 0 – Word 3: Slot 1
 - Word 4 – Word 7: Slot 2
 - Word 8 – Word 11: Slot 3
 - Word 12 – Word 15: Slot 4

6.7.7. Floating Point-Share Data Enabled

- Message Slots = 1 Total Size = 19

- 6.7.7.1. Request (PLC to IND560)
- Word 0: Reserved
 - Word 1 – Word 3: Message Slot 1
 - Word 4: Request Command : 1 - Read SDV / 2 - Write SDV
 - Word 5: NULL
 - Word 6 – Word 8: SDV name : example wf0101
 - Word 9 – Word 18: SDV write value

6.7.7.2. Response (IND560 to PLC)

Word 0 – Word 3: Message Slot 1

Word 4: SD access status

Word 5 – Word 14: SD read value

6.7.7.3. Floating Point-Share Data Enabled

Message Slots = 2 Total Size = 22

6.7.7.4. Request (PLC to IND560)

Word 0: Reserved

Word 1 – Word 3: Message Slot 1

Word 4 – Word 6: Message Slot 2

Word 7: Request Command: 1 - Read SDV / 2 - Write SDV

Word 8: NULL

Word 9 – Word 11: SDV name : example wt0101

Word 12 – Word 21: SDV write value

6.7.7.5. Response (IND560 to PLC)

Word 0 – Word 3: Message Slot 1

Word 4 – Word 7: Message Slot 2

Word 8: SD access status

Word 9 – Word 18: SD read value

6.7.8. Floating Point-Share Data Enabled

Message Slots = 3 Total Size = 25

6.7.8.1. Request (PLC to IND560)

Word 0: Reserved

Word 1 – Word 3: Message Slot 1

Word 4 – Word 6: Message Slot 2

Word 7 – Word 9: Message Slot 3

Word 10: Request Command: 1 - Read SDV / 2 - Write SDV

Word 11: NULL

Word 12 – Word 14: SDV name : example wt0101

Word 15 – Word 24: SDV write value

6.7.8.2. Response (IND560 to PLC)

Word 0 – Word 3: Message Slot 1

Word 4 – Word 7: Message Slot 2
 Word 8 – Word 11: Message Slot 3
 Word 12: SD access status
 Word 13 – Word 22: SD read value

6.7.9. Floating Point-Share Data Enabled

Message Slots= 4 Total Size = 28

6.7.9.1. Request (PLC to IND560)

Word 0: Reserved
 Word 1 – Word 3: Message Slot 1
 Word 4 – Word 6: Message Slot 2
 Word 7 – Word 9: Message Slot 3
 Word 10 – Word 12: Message Slot 4
 Word 13 : Request Command: 1 - Read SDV / 2 - Write SDV
 Word 14: NULL
 Word 15 – Word 17: SDV name: example wt0101
 Word 18 – Word 27: SDV write value

6.7.9.2. Response (IND560 to PLC)

Word 0 – Word 3: Message Slot 1
 Word 4 – Word 7: Message Slot 2
 Word 8 – Word 11: Message Slot 3
 Word 12 – Word 15: Message Slot 4
 Word 16: SD access status
 Word 17 – Word 26: SD read value

6.8. Controlling Discrete I/O Using a PLC Interface

The IND560 terminal provides the ability to directly control its discrete outputs and read its discrete inputs via the (digital) PLC interface options. System integrators should be aware that the IND560 discrete I/O updates are synchronized with the A/D rate, not with the PLC I/O scan rate. This may cause a noticeable delay in reading inputs or updating outputs as observed from the PLC to real world signals. Note that the outputs must be unassigned in the IND560 terminal setup in order to be controlled by the PLC.

6.9. Hardware Setup

6.9.1. Wiring

The IND560 terminal's PROFIBUS option card has a DB-9 connector to connect to the PROFIBUS network interface (Figure 6-3). Cable distance, type, and termination are specified by PROFIBUS. (Refer to the PLC documentation for cable design guidelines for the various PLCs.)

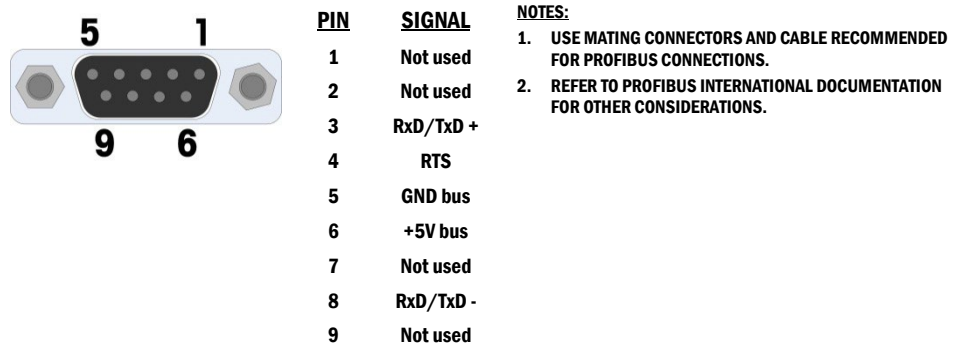

Figure 6-3: PROFIBUS Option Card DB-9 Connector

- The IND560 harsh unit requires a right angle connector Siemens part number 6ES7 972-0BA41-0XA0. The panel mount can use the right angle or straight connector METTLER TOLEDO part number 64054361.

6.10. Software Setup

The IND560 terminal automatically detects the presence of a PROFIBUS option card if one is installed, and adds the setup parameters to the options block. To configure the terminal for PROFIBUS, enter Setup and advance to the Communications/PLC/PROFIBUS sub-block (Figure 6-4).

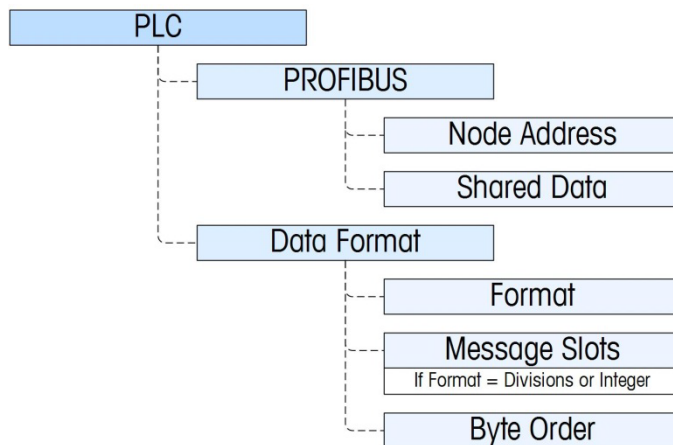

Figure 6-4: PROFIBUS Setup Block

6.10.1. PROFIBUS Setup Sub-Block

6.10.1.1. Profibus setup

The Profibus Setup block at **Communication > PLC > Profibus** lets you specify how the PROFIBUS interface is used. Enter a unique Node Address of 0–125. Set Shared Data as Enabled or Disabled

6.10.1.2. Data Format setup

6.10.1.2.1. Format

At **Communication > PLC > Data Format**, select the Format from a drop-down list. Select Divisions, Integer (default) or Floating Point.

6.10.1.2.2. Byte Order

Available selections are Standard, Byte Swap, Word Swap (default), and Double Word Swap. See Table 6-1 for definitions.

6.10.1.2.3. Message Slots

Select 1, 2, 3 or 4 slots.

6.10.2. PROFIBUS GSD or Type Files

There are thirteen configurations contained in the PROFIBUS GSD or type file for the IND560 terminal's different combinations of data formats. The length of the messages is different for each of the data formats, but the length of the input and output messages are the same within each format. The IND560 supports the message types shown in Table 6-4

- The PROFIBUS GSD file for the IND560 is included on the IND560 documentation CD (P/N 71209397).

Table 6-4: Message Types Supported by the IND560

Configuration		Functionality
I/O 2 Wrd	(2 words in/ 2 words out)	One message slot in integer/division
I/O 4 Wrd	(4 words in/ 4 words out)	Two message slots in integer/division
I/O 6 Wrd	(6 words in/ 6 words out)	Three message slots in integer/division
I/O 8 Wrd	(8 words in/ 8 words out)	Four message slots in integer/division
<hr/>		
I/O 17 Wrd	(17 words in/ 17 words out)	One message slot in integer/division and Shared Data Variable
I/O 19 Wrd	(19 words in/ 19 words out)	Two message slots in integer/division and Shared Data Variable
I/O 21 Wrd	(21 words in/ 21 words out)	Three message slots in integer/division and Shared Data Variable
I/O 23 Wrd	(23 words in/ 23 words out)	Four message slots in integer/division v and Shared Data Variable
<hr/>		
I/O 4 Wrd	(4 words in/ 4 words out)	One message slot in float ing point

Configuration		Functionality
I/O 8 Wrd	(8 words in/ 8 words out)	Two message slots in float ing point
I/O 12 Wrd	(12 words in/ 12 words out)	Three message slots in float ing point
I/O 16 Wrd	(16 words in/ 16 words out)	Four message slots in float ing point
I/O 19 Wrd	(19 words in/ 19 words out)	One message slot in float ing point and Shared Data Variable
I/O 22 Wrd	(22 words in/ 22 words out)	Two message slots in float ing point and Shared Data Variable
I/O 25 Wrd	(25 words in/ 25 words out)	Three message slots in float ing point and Shared Data Variable
I/O 28 Wrd	(28 words in/ 28 words out)	Four message slots in float ing point and Shared Data Variable

6.11. PROFIBUS Option Kit Part Numbers

There are two PROFIBUS options. CIMF part number 71209096 is vertically mounted and designed to work with the harsh IND560 and CIMF part number 71209097 is horizontally mounted and designed to work with the panel mount IND560. Refer to Figure 6-1 and Figure 6-2 for images of these two different boards. There are no associated spare parts with the PROFIBUS option kit. Table 6-5 shows what each kit contains.

Table 6-5: PROFIBUS Option Kit

Description	Qty.
Installation Instructions	1
PCB Package	1
Installation Kit	1
Gland Kit	1

6.12. Interfacing Examples

Figure 6-5 and Figure 6-6 show sample screens of hardware setup and I/O monitoring of the IND560 in the Siemens Step 7 software. The documentation CD, part number 71209397, contains complete versions of these examples.

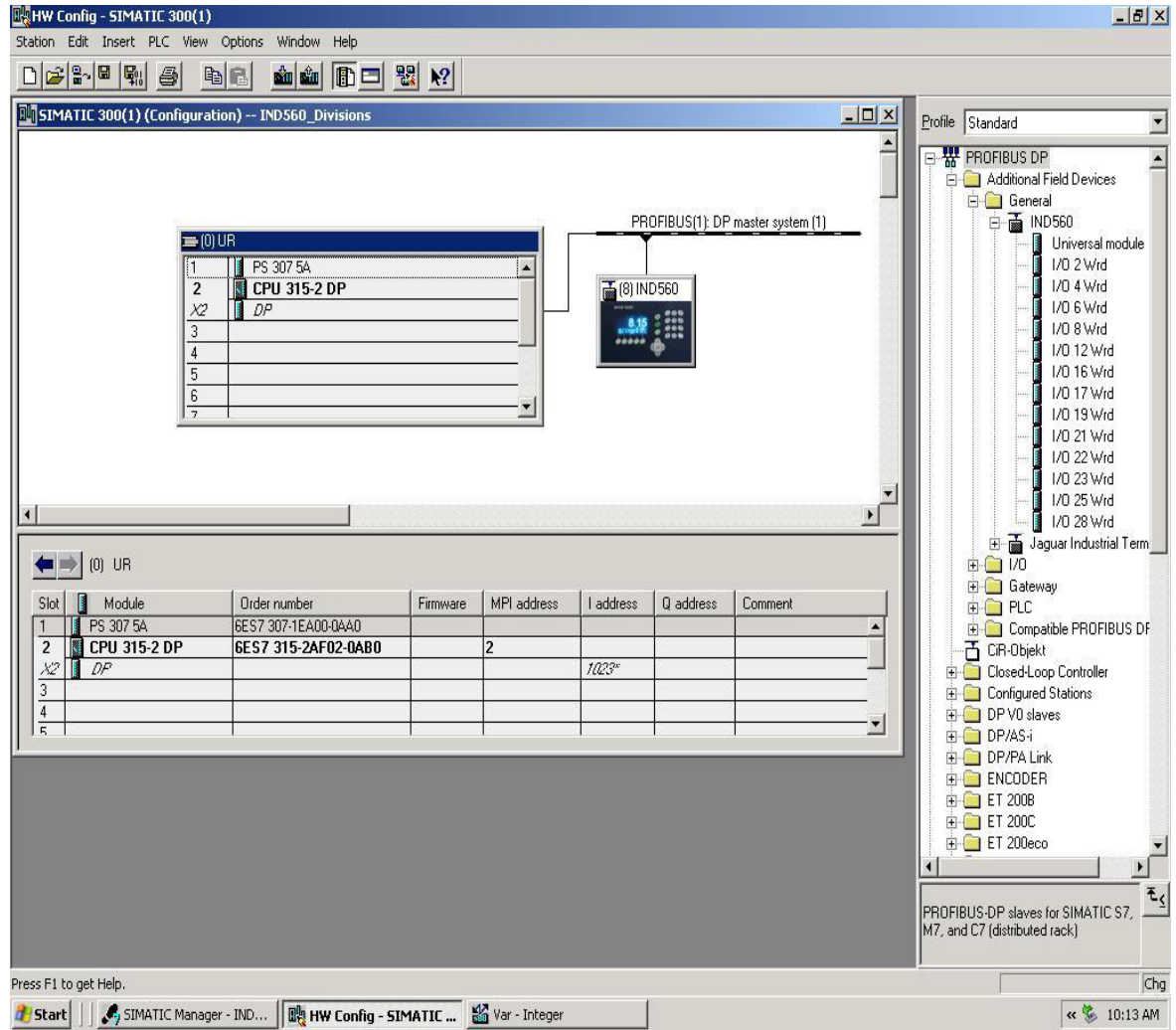

Figure 6-5: Hardware Setup

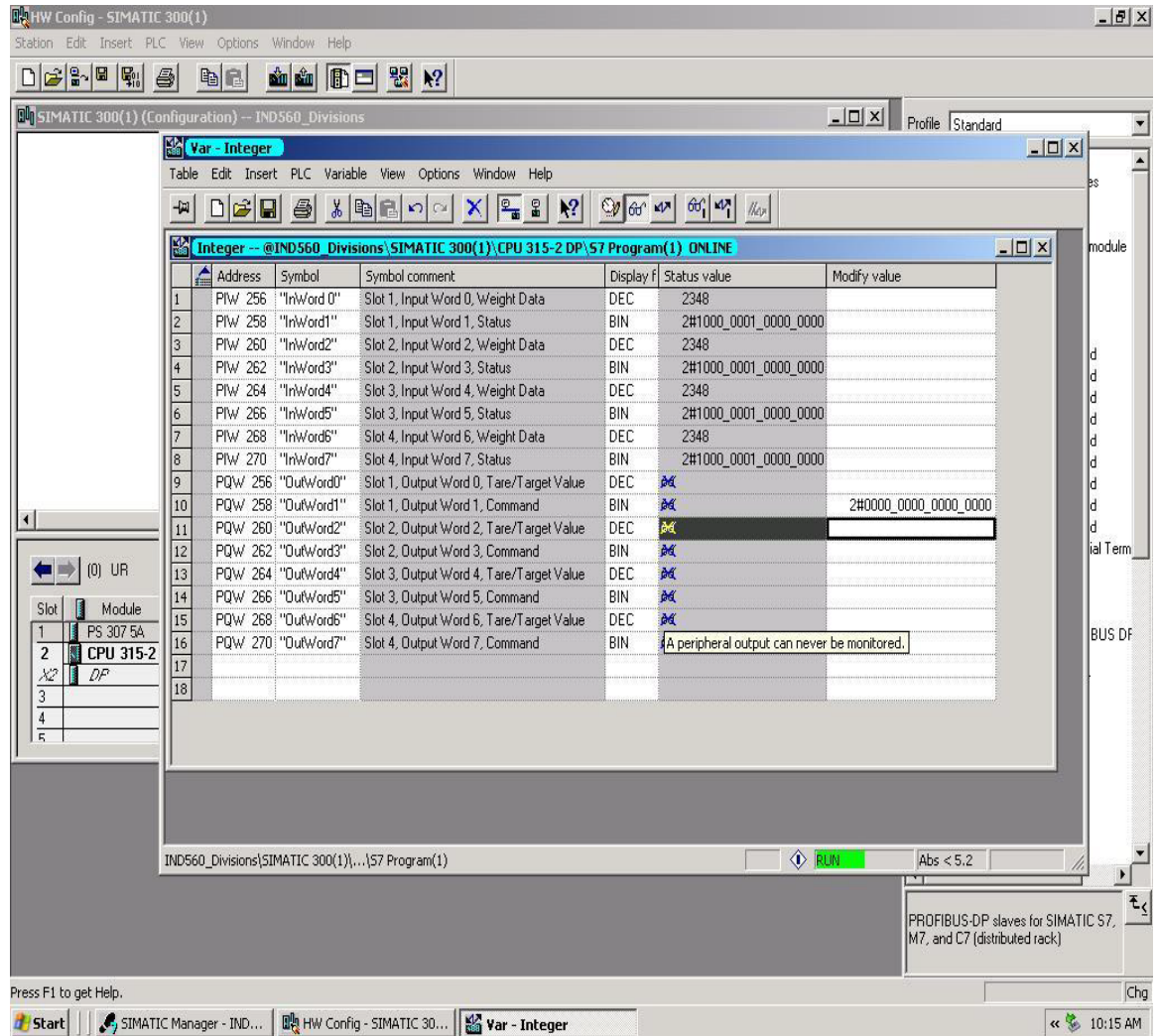

Figure 6-6: I/O Monitoring

A Integer and Division Data Formats

When one of these formats is selected, the IND560 will have two 16-bit words for input data and two 16-bit words for output data in each Message Slot. There can be up to four slots and the number of slots is setup at the IND560. The PLC's input data will contain one 16-bit word for the scale's weight information and one 16-bit word for bit encoded status information for each Message Slot. The IND560 will send specific weight data to the PLC input based on the selections the IND560 receives from the PLC's output data. The PLC's output words consist of one 16-bit integer value, which may be used to download a tare or target logic value, and one 16-bit word for bit encoded command information.

If the indicator is setup for more than one scale slot, the "Select 1, 2, or 3" commands in write word 1, select the type of data that will be displayed in its scale slot. Also note that most commands in write word 1 are only active in the first scale slot.

Table A-1 and Table A-2 provide detailed information on the integer and division data formats. Note that the designation of "Read" or "Write" data is based on the PLC's viewpoint-"Read" data refers to the PLC's input data and "Write" data refers to the PLC's output data.

If the indicator is setup for more than one scale slot, the "Select 1, 2, or 3" commands in write word 1, select the type of data that will be displayed in its scale slot. Also note that most commands in write word 1 are only active in the first scale slot.

Table A-1: Discrete Read Integer or Division – IND560 > PLC, per Message Slot

Bit number	First Word	Second Word
0	See Note 1	Target 1 ²
1		Target 2 ²
2		Target 2 ²
3		Comparator 5 ³
4		Comparator 4 ³
5		Comparator 3 ³
6		Comparator 2 ³
7		Comparator 1 ³
8		Enter Key ⁴
9		Input 1 ⁵
10		Input 2 ⁵

Bit number	First Word	Second Word
11		Input 3 ⁵
12		Motion ⁶
13		Net Mode ⁷
14		Update in Process ⁸
15		Data OK ⁹

A.1.1.1.1.

Notes for Table A-1

- 1 The first word is a 16 bit, signed integer that may represent the indicator's gross weight, net weight, displayed weight, tare weight, or rate. The **bits 0 to 2** in the PLC 2nd output word designate the type of data that is being sent by the indicator.
- 2 The second word **bits 0, 1 and 2** indicate the state of the target comparison logic. When in the material transfer mode; **bit 0** is Feed, **bit 1** is Fast Feed and **bit 2** is Tolerance Ok (within range). When in the over/under mode; **bit 0** is Under, **bit 1** is OK and **bit 2** is Over. An 'ON' condition is indicated by the bit being set to '1'; an 'OFF' condition is indicated by the bit being set to '0'.
- 3 The second word Comparator bits indicate the state of the associated comparator logic; when the bit is set to '1' the comparator state is 'ON'; when the bit is set to '0' the comparator state is 'OFF'. The setup of each comparator will determine when the state is 'ON' or 'OFF'.
- 4 The second word **bit 8** is set to '1' when the Enter Key has been pressed on the indicator keypad. The bit can be reset to '0' by changing the state of the second output word **bits 9, 10 and 11**.
5. The second word **bits 9, 10, and 11** indicate the state of the associated hardware input internal to the indicator; these are 0.1.1, 0.1.2 and 0.1.3. When the input is 'ON' the associated bit is set to '1'.
- 6 The second word **bit 12**; The motion bit is set to '1' when the scale is in motion (unstable).
- 7 The second word **bit 13**; The net mode bit is set to '1' when scale is in the net mode (a tare has been taken).
- 8 The second word **bit 14** (update in process) is set to '1' when the indicator is in process of updating the data to the PLC communications adapter. The PLC should ignore all data while this bit is set to '1'.
- 9 The second word **bit 15**; The data ok bit is set to '1' when the indicator operating conditions are normal. The bit is set to '0' during power-up, during indicator setup, when the scale is over capacity or under zero, and when in the x10 display mode; additionally, the first word integer value is set to '0'. The PLC should continuously monitor the data ok bit in the IND560 communication and also any PLC data connection fault bit that exists in the PLC (refer to the PLC manufacturer's documentation) to determine the validity of the data in the PLC.

IND560x NOTE: If communication between the IND560x and the ACM500 is interrupted, the Data OK bit is not affected and will remain at its last transmitted status.

Table A-2: Discrete Write Integer or Division –PLC > IND560, per Message Slot

Bit number	First Word	Second Word [Scale Command]
0	See Note 1	Select 1 ²
1		Select 2 ²
2		Select 3 ²
3		Load Tare 1 st message slot only ¹²
4		Clear Tare ⁴ 1 st message slot only ¹²
5		Tare ⁵ 1 st message slot only ¹²
6		Print ⁶ 1 st message slot only ¹²
7		Zero ⁷ 1 st message slot only ¹²
8		Start/Abort Target ⁸ 1 st message slot only ¹²
9		Message Display Mode ⁹ 1 st message slot only
10		Message Display Mode ⁹ 1 st message slot only ¹²
11		Message Display Mode ⁹ 1 st message slot only ¹²
12		Output 1 ¹⁰ 1 st message slot only ¹²
13		Output 2 ¹⁰ 1 st message slot only ¹²
14		Output 3 ¹⁰ 1 st message slot only ¹²
15	Load Target ¹¹ 1 st message slot only ¹²	

A.1.1.1.2.

Notes for Table A-2

- 1 First word is a 16 bit, signed integer that represents a value to be downloaded to the indicator. The value represents a tare or target value. When using the divisions format, the data set must be in the number of divisions, not an integer weight value. A value must be loaded in this word before setting the **bits 3** or **15** in the second word. To load the target value ,first enter the value into the first word and then set bit 15 (Load Target) "On"
- 2 The select bits change the type of data being sent from the indicator in the first word. Use a decimal value in binary format within **bits 0, 1, and 2** to change the data reported by the indicator. '0' = gross weight, '1' = net weight, '2' = displayed weight, '3' = tare weight, '4' = target, '5' = rate; any value above 5 will equal gross weight.
- 3 A transition from '0' to '1' will cause the value in the first word to be loaded into the tare register of the indicator and set the indicator into the net mode. Set this bit to '1' only after the first word has been loaded with the required value.
- 4 A transition from '0' to '1' will cause the indicator tare register to be set to '0' and the indicator will be set to the gross weight mode.
- 5 A transition from '0' to '1' will cause the weight on the scale to be used as the tare value and set the indicator to the net mode (equivalent to a tare command). Note that the scale will not tare while the scale is "In Motion". If the indicator has not tared within 3 seconds, the command must be resent. A good practice is to check for no motion –bit 12 of input word 1-"Off"
- 6 A transition from '0' to '1' will issue a print command.

- 7 A transition from '0' to '1' will cause the scale to re-zero, but only within the ranges established in scale setup.
- 8 A transition from '0' to '1' will cause the target logic to start. A transition from '1' to '0' will cause the target logic to abort. The use of the PLC in conjunction with the indicator console keypad and/or a remote input is not advised, as unexpected results may occur.
- 9 The message display mode bits will cause messages to be displayed on the indicator display above the soft key prompts; messages are limited to 20 characters. The use of the display mode bits will clear the Enter Key bit in the second word of the indicator output data. The message display mode bits cause a value to be written to shared data pd0119, which is available for use by Task Expert applications. The transition from '0' to a decimal value in binary form to the second word **bits 9, 10 and 11** will initiate the message events.
 - Setting the message display bits to a value of '1' will cause the characters in shared data aw0101 to be displayed and pd0119 will be set to '1'.
 - Setting to '2' = display aw0102 and pd0119 = '2'.
 - Setting to '3' = display aw0103 and pd0119 = '3'.
 - Setting to '4' display aw0104 and pd0119 = '4'.
 - Setting to '5' = display aw0105 and pd0119 = '5'.
 - Setting to '6' = start Prompt sequence, pd0119 = '6' and xc0134 = '1'.
 - Setting to '7' = display pd0118 and pd0119 = '7'.The message display mode bits must return to '0' before a new message can be displayed.
- 10 The output bits will cause the associated hardware output to be turned 'ON' and 'OFF'. This is the indicator internal outputs only; 0.1.1, 0.1.2 and 0.1.3. The output bits will not override the hardware outputs being used by the indicator logic as setup within the indicator. Setting a bit to '1' will cause the output to turn 'ON'; setting the bit to '0' will cause the output to turn 'OFF'.
- 11 A transition from '0' to '1' will cause the value in the first word to be loaded into the target register of the indicator and will be used the next time the target logic is started. Set this bit to '1' only after the first word has been loaded with the required value.
- 12 These are bit commands to the indicator that function only in the first message slot.

B Floating Point Format

B.1. Operational Overview

The IND560 uses integer commands from the PLC to select the floating point weight input data. The IND560 recognizes a command when it sees a new value in the Message Slot command word. If the command has an associated floating point value (for example: loading a target value), it must be loaded into the floating point value words before the command is issued. Once the IND560 recognizes a command, it acknowledges the command by setting a new value in the command acknowledge bits of the scale's command response word. The IND560 also tells the PLC what floating point value is being sent (via the floating point input indicator bits of the command response word). The PLC should wait until it receives the command acknowledgment from the IND560 before sending another command.

The IND560 can report two types of values to the PLC: real-time and static. When the PLC requests a real-time value, the IND560 acknowledges the command from the PLC once but sends and updates the value at every interface update cycle. If the PLC requests a static value, the IND560 acknowledges the command from the PLC once and updates the value once. The IND560 will continue to send this value until it receives a new command from the PLC. Gross weight and net weight are examples of real-time data. Tare weight, target, feed, and tolerance values are examples of static data.

The IND560 can send a rotation of up to nine different real-time values. The PLC sends commands to the IND560 to add a value to the rotation. Once the rotation is established, the PLC must instruct the IND560 to begin its rotation automatically, or the PLC may control the pace of rotation by instructing the IND560 to advance to the next value. If the IND560 is asked to automatically alternate its output data, it will switch to the next value in its rotation at the next interface update cycle. (The interface update cycle has an update rate of up to 20 Hz or 58 milliseconds.)

The PLC may control the rotation by sending alternate report next field commands (1 and 2). When the PLC changes to the next command, the IND560 switches to the next value in the rotation order. The IND560 stores the rotation in its shared data so the rotation does not have to be re-initialized after each power cycle. When the PLC does not set up an input rotation, the default input rotation consists of gross weight only. See the floating-point command examples in Table B-5 through Table B-8 for additional information. The method of handling string and floating point data varies between PLC types. The IND560 provides floating point data in the order entered in Data Format setup.

Table B-1 through Table B-8 provide detailed information on the floating-point data format. Read data refers to the PLC's input data and write data refers to the PLC's output data.

Table B-1: Discrete Read Floating Point – IND560 > PLC Input, per Message Slot

Bit number	1 st Word Command Response	2 nd Word FP value	3 rd Word FP value	4 th Word Scale Status	
0	RESERVED	See Note 4	See Note 4	Target 1 ⁵	
1				Comparator 1 ⁶	
2				Target 2 ⁵	
3				Comparator 2 ⁶	
4				Target 3 ⁵	
5				Always = 1	
6				TE bit 1 ⁷	
7				TE bit 2 ⁷	
8				FP Input Indicator 1 ¹	Enter Key ⁸
9				FP Input Indicator 2 ¹	Input 1 ⁹
10				FP Input Indicator 3 ¹	Input 2 ⁹
11				FP Input Indicator 4 ¹	Input 3 ⁹
12				FP Input Indicator 5 ¹	Motion ¹⁰
13				Data integrity1 ²	Net Mode ¹¹
14				Command Ack 1 ³	Data Integrity 2 ²
15	Command Ack 2 ³	Data OK ¹²			

Notes for Table B-1

- 1 The Floating Point Indicator bits (1st word bits 8-12) are used to determine what type of floating or other data is being sent in the second and third words. See the Floating Point Indicator Table for the information from these bits in decimal format.
- 2 The Data Integrity bits (1st word **bit 13** and 4th word **bit 14**) should be used to assure that communication is still valid and that data are valid. Both of these bits are set to '1' for one update from the indicator, then are set to '0' for the next update from the indicator and this change of state is on every update and is constant as long as the communications link is not disrupted.
- 3 The first word Command Acknowledge bits (**bits 14** and **15**) are used by the indicator to inform the PLC that a new command was received. The decimal values of these bits will rotate sequentially from 1 to 3 as long as a command other than '0' is being sent (3rd output word). The decimal value of these bits will be '0' when the 3rd output word (PLC output command word) is decimal '0'.
- 4 The second and third words are 32 bit, single precision floating point data. The data may represent the various scale weight data or setup configuration data. The PLC output command word determines what data will be sent.
- 5 The fourth word, **bits 0, 2** and **4** indicate the state of the Target comparison logic. When in the material transfer mode; **bit 0** is Feed, **bit 2** is Fast Feed and **bit 4** is Tolerance Ok (within range). When in the over/under mode; **bit 0** is Under, **bit 2** is OK and **bit 4** is Over. An 'ON' condition is indicated by the bit being set to '1'; an 'OFF' condition is indicated by the bit being set to '0'.

- 6 The fourth word; Comparator bits indicate the state of the associated comparator logic; when the bit is set to '1' the comparator state is 'ON'; when it is set to '0' the comparator state is 'OFF'. The setup on each comparator will determine when the state is 'ON' or 'OFF'.
- 7 The fourth word; TE **bit 1** is the state of shared data variable ac0101. TE **bit 2** is the state of shared data variable ac0102. A Task Expert (TE) application may use these bits to instruct the PLC to perform a procedure or function.
NOTE: Interminals with software revisions below 4.03, TE bit 1 is triggered by either ac0101 or as0101, and TE bit 2 is triggered by either ac0102 or as0102.
- 8 The fourth word **bit 8** is set to '1' when the Enter Key has been pressed on the keypad of the indicator. The bit can be reset to '0' by sending the command 75 (decimal) in the PLC output command word.
- 9 The fourth word **bits 9, 10, and 11** indicate the state of the associated hardware input internal to the indicator; these are 0.1.1, 0.1.2 and 0.1.3. When the input is 'ON' the associated bit is set to '1'.
- 10 The fourth word **bit 12**; The motion bit is set to '1' when the scale is in motion.
- 11 The fourth word **bit 13**; The net mode bit is set to '1' when scale is in the net mode (a tare has been taken).
- 12 The fourth word **bit 15**; The data ok bit is set to '1' when the indicator operating conditions are normal, and when in the x10 display mode. The bit is set to '0' during power-up, during indicator setup, when the scale is over capacity or under zero. The PLC should continuously monitor the data ok bit in the IND560 communication and also any PLC data connection fault bit that exists in the PLC (refer to the PLC manufacturer documentation) to determine the validity of the data in the PLC.
IND560x NOTE: If communication between the IND560x and the ACM500 is interrupted, the Data OK bit is not affected and will remain at its last transmitted status.

Table B-2: Floating Point Input Indication

Dec	Data	Dec	Data	Dec	Data
0	Gross Weight ¹	11	Low-pass filter frequency	22	Weigh-in +tolerance value ³
1	Net Weight ¹	12	Notch filter frequency	23	Weigh-in -tolerance value ³
2	Tare Weight ¹	13	Target value ³	24	Weigh-out target value ³
3	Fine Gross Weight ¹	14	+ Tolerance value ³	25	Weigh-out fine feed value ³
4	Fine Net Weight ¹	15	Fine feed value ³	26	Weigh-out spill value ³
5	Fine Tare Weight ¹	16	- Tolerance value ³	27	Weigh-out +tolerance value ³
6	Rate ¹	17	Spill value ³	28	Weigh-out -tolerance value ³
7	Custom field #1	18	Primary units, low increment size	29	Last indicator error code
8	Custom field #2 ²	19	Weigh-in target value ³	30	No data response command successful
9	Custom field #3	20	Weigh-in fine feed value ³	31	Invalid Command
10	Custom field #4 ²	21	Weigh-in spill value ³		

Notes for Table B-2

- 1 Data is refreshed on every indicator update
- 2 Data is ASCII characters and is limited to the first 4 characters
- 3 Value that is in the Target registers, may not be the active Target value

Table B-3: Discrete Write Floating Point – PLC >> IND560, per Message Slot

Bit Number	1 st Word [Scale command]	2 nd Word	3 rd Word
0	See Note 1	See Notes 2 and 3	
1			
2			
3			
4			
5			
6			
7			
8			
9			
10			
11			
12			
13			
14			

Notes for Table B-3

- 1 The first word is a 16 bit integer and is used to send commands to the indicator. The commands are used to:
 - instruct the indicator to report a specific type of data in words 2 and 3. Examples are Gross Weight, Net Weight, + Tolerance Value, etc.
 - instruct the indicator to load the floating point data in the second and third words for a tare value, target value; or other value
 - instruct the indicator to turn on internal outputs or perform a functions, such as Clear Tare, Print,Tare, Start Weigh,etc
- 2 The second and third words represent a 32 bit single precision floating point value that will be used for downloading a tare, target or other value to the indicator.
- 3 Not all commands require a floating point value in the second and third words.

Table B-4: PLC Output Command Table (Floating Point Only)

Dec	Hex	Command	SDName
0	0	Report next rotation field @ next A/D update ¹	
1	1	Report next rotation field ^{1,3}	
2	2	Report next rotation field ^{1,3}	
3	3	Reset (cancel) rotation	
10	A	Report gross weight ²	
11	B	Report net weight ²	
12	C	Report tare weight ²	
13	D	Report fine gross weight ²	
14	E	Report fine net weight ²	
15	F	Report fine tare weight ²	
16	10	Report Rate ²	
17	11	Report custom float value #1 ^{2,5}	aj0101
18	12	Report custom string value #2 ^{2,4,5}	ak0101
19	13	Report low-pass filter frequency ^{2,5}	
20	14	Report notch filter frequency ²	
21	15	Report target value ^{2,5}	
22	16	Report (+) tolerance value ^{2,5}	
23	17	Report fine feed ^{2,5}	
24	18	Report (-) tolerance value ^{2,5}	
25	19	Report spill value ⁵	
27	1B	Report custom float value #3 ⁵	aj0102
28	1C	Report custom string value #4 ⁵	ak0102
30	1E	Report primary units ⁵	
40	28	Add gross weight to rotation ⁷	
41	29	Add net weight to rotation ⁷	

Dec	Hex	Command	SDName
42	2A	Add tare weight to rotation ⁷	
43	2B	Add fine gross weight to rotation ⁷	
44	2C	Add fine net weight to rotation ⁷	
45	2D	Add fine tare weight to rotation ⁷	
46	2E	Add rate to rotation ⁷	
47	2F	Add custom value #1 to rotation ⁷	aj0101
48	30	Add custom value #2 to rotation ⁷	ak0101
60	3C	Load programmable tare value ⁶	
61	3D	Pushbutton tare command ⁷	
62	3E	Clear command ⁷	
63	3F	Print command ⁷	
64	40	Zero command ⁷	
68	44	Trigger 1 command ⁷	
69	45	Trigger 2 command ⁷	
70	46	Trigger 3 command ⁷	
71	47	Trigger 4 command ⁷	
72	48	Trigger 5 command ⁷	
73	49	Set low-pass filter frequency ⁶	
74	4A	Set notch filter frequency ⁶	
75	4B	Reset (clear) ENTER key ⁷	
80	50	Clear display message ^{7,8}	
81	51	Display Message 1 ^{7,8}	
82	52	Display Message 2 ^{7,8}	
83	53	Display Message 3 ^{7,8}	
84	54	Display Message 4 ^{7,8}	
85	55	Display Message 5 ^{7,8}	

Dec	Hex	Command	SDName
86	56	Display Message 6 ^{7,8}	
87	57	Display Message 7 ^{7,8}	
88	58	Disable weight display ⁷	
89	59	Enable weight display ⁷	
90	5A	Set discrete output 0.1.1 "ON" ⁷	di0105
91	5B	Set discrete output 0.1.2 "ON" ⁷	di0106
92	5C	Set discrete output 0.1.3 "ON" ⁷	di0107
93	5D	Set discrete output 0.1.4 "ON" ⁷	di0108
100	64	Set discrete output 0.1.1 "OFF" ⁷	di0105
101	65	Set discrete output 0.1.2 "OFF" ⁷	di0106
102	66	Set discrete output 0.1.3 "OFF" ⁷	di0107
103	67	Set discrete output 0.1.4 "OFF" ⁷	di0108
110	6E	Set target value ⁶	
111	6F	Set target fine feed value ⁶	
112	70	Set - tolerance value ⁶	
114	72	Start target comparison ⁷	
115	73	Abort target comparison ⁷	
116	74	Target use gross weight ⁷	
117	75	Target use net weight ⁷	
119	77	Weigh-In Start ^{7,10}	
120	78	Weigh-Out Start ^{7,10}	
121	79	Enable target latching ⁷	
122	7A	Disable target latching ⁷	
123	7B	Reset target latch ⁷	
124	7C	Set Spill Value ⁶	
131	83	Set (+) tolerance value ⁶	
160	A0	Apply scale setup (reinitialize) ^{7,9}	

Dec	Hex	Command	SDName
162	A2	Disable indicator tare (IDNet only) ⁷	
163	A3	Enable indicator tare (IDNet only) ⁷	
170	AA	Set weigh-in target value ^{6,10,11}	af0161
171	AB	Set weigh-in fine feed value ^{6,10,11}	af0163
172	AC	Set weigh-in spill value ^{6,10,11}	af0162
173	AD	Set weigh-in +tolerance value ^{6,10,11}	af0164
174	AE	Set weigh-in -tolerance value ^{6,10,11}	af0165
175	AF	Set weigh-out target value ^{6,10,11}	af0151
176	B0	Set weigh-out fine feed value ^{6,10,11}	af0153
177	B1	Set weigh-out spill value ^{6,10,11}	af0152
178	B2	Set weigh-out +tolerance value ^{6,10,11}	af0154
179	B3	Set weigh-out -tolerance value ^{6,10,11}	af0155
180	B4	Report weigh-in target value ^{6,10}	
181	B5	Report weigh-in fine feed value ^{6,10}	
182	B6	Report weigh-in spill value ^{6,10}	
183	B7	Report weigh-in +tolerance value ^{6,10}	
184	B8	Report weigh-in -tolerance value ^{6,10}	
185	B9	Report weigh-out target value ^{6,10}	
186	BA	Report weigh-out fine feed value ^{6,10}	
187	BB	Report weigh-out spill value ^{6,10}	
188	BC	Report weigh-out +tolerance value ^{6,10}	
189	BD	Report weigh-out -tolerance value ^{6,10}	
190	BE	Add all weigh-in values to rotation ^{6,10}	
191	BF	Add all weigh-out values to rotation ^{6,10}	
192	C0	Trigger OK key ⁷	ac0109
193	C1	Trigger ENTER key ⁷	xc0130
194	C2	Trigger weigh-in pause ^{7,10}	

Dec	Hex	Command	SDName
195	C3	Trigger weigh-in resume	ac0101
196	C4	Trigger weigh-in abort ^{7,10}	
197	C5	Trigger weigh-out pause ^{7,10}	
198	C6	Trigger weigh-out resume ^{7,10}	ac0102
199	C7	Trigger weigh-out abort ^{7,10}	
210	D2	Set Comparator 1 limit	
211	D3	Set Comparator 1 high limit	
212	D4	Set Comparator 2 limit	
213	D5	Set Comparator 2 high limit	
214	D6	Set Comparator 3 limit	
215	D7	Set Comparator 3 high limit	
216	D8	Set Comparator 4 limit	
217	D9	Set Comparator 4 high limit	
218	DA	Set Comparator 5 limit	
219	DB	Set Comparator 5 high limit	
220	DC	Disable Keypad	
221	DD	Enable Keypad	
222	DE	Report Comparator 1 limit	
223	DF	Report Comparator 1 high limit	
224	E0	Report Comparator 2 limit	
225	E1	Report Comparator 2 high limit	
226	E2	Report Comparator 3 limit	
227	E3	Report Comparator 3 high limit	
228	E4	Report Comparator 4 limit	
229	E5	Report Comparator 4 high limit	
230	E6	Report Comparator 5 limit	
231	E7	Report Comparator 5 high limit	

Dec	Hex	Command	SDName
232	E8	Apply Comparator Values	

Notes for Table B-4

- 1 Rotation is set up by commands 40 to 48 (dec). On each indicator update the next field of the rotation setup is reported in the second and third words of the floating point output from the indicator. The floating point indication date reports what the field data represents. To keep up with the rotation changes, the PLC program scan time should be 30 milliseconds or less. A command of '0' without rotation setup will report the scale gross weight. The commands acknowledge bits are set to the value of '0'.
- 2 A command that requests data that is refreshed on every indicator update.
- 3 Toggling between commands 1 and 2 will allow the PLC to control the rotation field change.
- 4 Only 4 characters of a string field are reported; the PLC must process the data as a string value.
- 5 A command that request a specific value; as long as the request is in the command word to the indicator no other data will be reported by the indicator.
- 6 A command that requires a floating point value be in the second and third word when the command is sent to the indicator. If the command is successful the returned floating point value will equal the value sent to the indicator.
- 7 A command that will not report back a value; the floating point data from the indicator will be zero.
- 8 The message display commands will cause messages to be displayed on the indicator display above the soft key prompts; this is limited to 20 characters. The message

display commands cause a value to be written to shared data PDO119; PDO119 values can be use by Task Expert applications. The command 81 to 87 (dec) will initiate the message events. Command 81 will cause the characters in shared data AW0101 to be displayed and PDO119 will be set to '1'. Command 82 = display AW0102 and PDO119 = '2'. Command 83 = display AW0103 and PDO119 = '3'. Command 84 display AW0104 and PDO119 = '4'. Command 85 = display AW0105 and PDO119 = '5'. Command 86 = start Prompt sequence, PDO119 = '6' and XC0134 = '1'. Command = display PDO118 and PDO119 = '7'. Command 80 (dec) will remove the message display.

- 9 If shared data classes pl, ds, ll, nt, ce, zr, ct, cm, xs, cs, dp, wk, ao, rp, or dc are changed by the PLC this command (160 dec) will trigger the changes into effect. Shared data is not available with the AB-RIO, DeviceNet and Modbus TCP.
- 10 A command that can only be used with the IND560 Fill.
- 11 If Fill-560 is not installed in the terminal, this command can be used to access the corresponding Shared Data field incorporated into a custom TaskExpert program.

B.1.1.1. Floating Point Command Examples

Table B-5: Data Requirement: Only Net Weight Sent (continuously) for Scale 1

Step #	Scale Command (From PLC)	Scale Floating Point Value	Command Response From Terminal	Floating Point Value
1 (PLC sends command to IND560 terminal to report net weight)	11 (dec) loaded into command word 0	none required		
2 (IND560 terminal sees new command)			Command ack. = 1 F.P. ind. = 1 (net)	Net weight in floating point

As long as the PLC leaves the 11 (dec) in the command word, the IND560 terminal will update the net value every interface update cycle.

Table B-6: Data Requirement: Load Target Value = 21.75 for Scale 1

Step #	Scale command (from PLC)	Scale Floating Point Value	Command response from terminal	Floating Point Value
1 (PLC loads floating point value first)		floating point value = 21.75		
2 (PLC sends command to set target 1 cutoff value)	110 (dec) loaded into command word 0	floating point value = 21.75		
3 (IND560 terminal sees new command, loads the value into the target and ends a return message to indicate the new target value)			Command ack. = 1 F.P. ind = 13	Floating point value = 21.75
4 (PLC instructs IND560 terminal to start "using" new target value)	114 (dec) loaded into command word 0			
5 (IND560 terminal sees new command)			Command ack. = 2 F.P. ind = 30	0.0

The PLC should always wait to receive a command acknowledgment before sending the next command to the IND560 terminal. After the PLC finishes loading its target value, it can resume monitoring the weight information required by sending a command to report some type of weight or set up a rotation of reported data.

Table B-7: Data Requirement: Rotation of Gross Weight and Rate Updated on Interface Update Cycle

Step #	Scale Command (from PLC)	Scale Floating Point Value	Command Response from Terminal	Floating Point Value
1 (PLC clears out any previous rotation with reset)	3 (dec) loaded into command word 0			
2 (IND560 terminal sees new command)			Command ack. = 1 F.P. ind = 30	0.0
3 (PLC adds gross weight to rotation)	40 (dec) loaded into command word 0	(null value)		
4 (IND560 terminal sees new command)			Command ack. = 2 F.P. ind = 30	0.0
5 (PLC adds rate to the rotation)	46 (dec) loaded into command word 0			
6 (IND560 terminal sees new command)			Command ack. = 3 F.P. ind = 30	0.0

At this point, the rotation has been set up. Now the PLC needs to command the IND560 terminal to begin the rotation.

7 (PLC sends the command to begin the rotation at interface update cycle)	0 (dec) loaded into command word 0			
8 (IND560 terminal sends gross weight at interface update cycle ~ 60 msec)			Command ack. = 0 F.P. ind = 0	Floating point value = gross wt.
9 (PLC leaves 0 in its command word and the IND560 terminal sends the rate value at the next interface update cycle)	0 (dec) loaded into command word 0		Command ack. = 0 F.P. ind = 6	Floating point value = rate
10 (PLC leaves 0 in its command word and IND560 terminal sends the gross value at next interface update cycle)	0 (dec) loaded into command word 0		Command ack. = 0 F.P. ind = 0	Floating point value = gross wt.

Step #	Scale Command (from PLC)	Scale Floating Point Value	Command Response from Terminal	Floating Point Value
11 (PLC leaves 0 in command word and IND560 terminal sends the rate value at the next interface update cycle)	0 (dec) loaded into command word 0	RESERVED for Future Use	Command ack. = 0 F.P. ind = 6	Floating point value = rate

This rotation continues until the PLC sends a different command. At approximately every 60 msec the IND560 terminal updates its data with the next field in its rotation. The PLC must check the floating point indication bits to determine which data is in the floating point value.

Table B-8: Data Requirement: Rotation of Net Weight and Rate Updated on PLC Command

Step #	Scale command (from PLC)	Scale Floating Point Value	Command response from terminal	Floating Point Value
1 (PLC clears out any previous rotation with reset)	3 (dec) loaded into command word 0			
2 (IND560 terminal sees new command)			Command ack. = 1 F.P. ind = 30	0.0
3 (PLC adds net weight to rotation)	41 (dec) loaded into command word 0	(null value)		
4 (IND560 terminal sees new command)			Command ack. = 2 F.P. ind = 30	0.0
5 (PLC adds rate to the rotation)	46 (dec) loaded into command word 0	RESERVED for Future Use		
6 (IND560 terminal sees new command)			Command ack. = 3 F.P. ind = 30	0.0

At this point, the rotation has been set up. Now the PLC needs to send commands to the IND560 terminal to begin the rotation and advance to the next value when required.

7 (PLC sends the command to report the first field in the rotation.)	1 (dec) loaded into command word 0			
8 (IND560 terminal acknowledges the command and sends net			Command ack. = 1 F.P. ind = 1	Floating point value = net weight

Step #	Scale command (from PLC)	Scale Floating Point Value	Command response from terminal	Floating Point Value
weight at every interface update cycle until the PLC gives the command to report the next rotation field.)				
9 (PLC sends the command to report the next field.) Note: if the PLC leaves the 1 (dec) in the command, the IND560 terminal does NOT see this as another command to report the next rotation field.	2 (dec) loaded into command word 0			
10 (IND560 terminal acknowledges the command and sends rate at every interface update cycle until the PLC gives the command to report the next rotation field.)		RESERVED for Future Use	Command ack. = 2 F.P. ind = 6	Floating point value = rate
11 (PLC sends the command to report the next field in the rotation.)	1 (dec) loaded into command word 0			
12 (IND560 terminal acknowledges the command and sends net weight at every interface update cycle until the PLC gives the command to report the next rotation field.)			Command ack. = 1 F.P. ind = 1	Floating point value = net wt.
13 (PLC sends the command to report the next field.)	2 (dec) loaded into command word 0			
14 (IND560 terminal acknowledges the command and sends rate at every interface update cycle until the PLC gives		RESERVED for Future Use	Command ack. = 2 F.P. ind = 6	Floating point value = rate

Step #	Scale command (from PLC)	Scale Floating Point Value	Command response from terminal	Floating Point Value
the command to report the next rotation field.)				

At approximately every 60 msec the IND560 terminal updates its data with new data, but it does not advance to the next field in the rotation until the PLC sends it the command to report the next field. The PLC should check the floating point indication bits to determine which data is in the floating point value

C PLC Data Sizes

C.1. Introduction

This appendix provides information about data sizes for Integer, Division, and Floating Point data transfer between the IND560 and a PLC system. RSLogix5000 communication formats are included as an example of how the 8 bit sizes required by the IND560 are translated into 16-bit integer sizes that can be used by the RSLogix5000.

C.2. Integer and Divisions Data Formats

In the IND560, both Integer and Division data formats are 16-bit signed integers that support values of -32,768 to +32,767.

Integer is the weight in the displayed units. Divisions are the internal calibrated scale divisions – displayed weight divided by division size. Divisions are used to accommodate large weight values in integer form. The Divisions value must be multiplied by the division size in the PLC to obtain the weight in the displayed units. The IND560 integer data formats use no overhead bytes, with 4 bytes input and 4 bytes output per message slot.

■ For this appendix, Input and Output references are made with respect to the PLC.

Table C-1 shows data sizes per message slot for data sent to the PLC and received from the PLC by the IND560. The corresponding RSLogix5000 format is included as an example.

Table C-1: IND560 Integer Data Sizes

Message Slots	IND560 Floating Point Data Bytes (8 bit)		Logix5000 Comm Format INT (16 bit)	
	PLC Input from IND560	PLC Output to IND560	Input Size	Output Size
1	4	4	2	2
2	8	8	4	4
3	12	12	6	6
4	16	16	8	8

C.3. Floating Point Data Format

The IND560 uses IEEE-754 single precision floating point. The IND560 Floating Point Input has a 0 byte overhead and uses 8 bytes per message slot. The Output has a 2 byte overhead and uses 6 bytes per message slot.

- Input and Output references are always with respect to the PLC.

The IND560 Floating Point data format uses 16 bit words. INT is the only communication format recommended for use with the IND560 Floating Point format. Note that DINT (double integer) is not compatible with even quantities of IND560 message slots, because – as seen in Table C-2 – the IND560 input (PLC output) is not in multiples of four 16 bit words for even message slot quantities.

Table C-2: IND560 Floating Point Data Sizes

Message Slots	IND560 Floating Point Data Bytes (8 bit)		Logix5000 Comm Format INT (16 bit)	
	PLC Input from IND560	PLC Output to IND560	Input Size	Output Size
1	8	8	4	4
2	16	14	8	7
3	24	20	12	10
4	32	26	16	13

D ASCII Characters

D.1. Standard Characters

Char.	Dec.	Hex.
NUL	0	00
SOH	1	01
STX	2	02
ETX	3	03
EOT	4	04
ENQ	5	05
ACK	6	06
BEL	7	07
BS	8	08
HT	9	09
LF	10	0A
VT	11	0B
FF	12	0C
CR	13	0D
SO	14	0E
SI	15	0F
DLE	16	10
DC1	17	11
DC2	18	12
DC3	19	13
DC4	20	14
NAK	21	15
SYN	22	16
ETB	23	17
CAN	24	18
EM	25	19
SUB	26	1A
ESC	27	1B
FS	28	1C
GS	29	1D
RS	30	1E
US	31	1F
SP	32	20
!	33	21
"	34	22

Char.	Dec.	Hex.
#	35	23
\$	36	24
%	37	25
&	38	26
'	39	27
(40	28
)	41	29
*	42	2A
+	43	2B
,	44	2C
-	45	2D
.	46	2E
/	47	2F
0	48	30
1	49	31
2	50	32
3	51	33
4	52	34
5	53	35
6	54	36
7	55	37
8	56	38
9	57	39
:	58	3A
;	59	3B
<	60	3C
=	61	3D
>	62	3E
?	63	3F
@	64	40
A	65	41
B	66	42
C	67	43
D	68	44
E	69	45

Char.	Dec.	Hex.
F	70	46
G	71	47
H	72	48
I	73	49
J	74	4A
K	75	4B
L	76	4C
M	77	4D
N	78	4E
O	79	4F
P	80	50
Q	81	51
R	82	52
S	83	53
T	84	54
U	85	55
V	86	56
W	87	57
X	88	58
Y	89	59
Z	90	5A
[91	5B
\	92	5C
]	93	5D
^	94	5E
_	95	5F
`	96	60
a	97	61
b	98	62
c	99	63
d	100	64
e	101	65
f	102	66
g	103	67
h	104	68

Char.	Dec.	Hex.
i	105	69
j	106	6A
k	107	6B
l	108	6C
m	109	6D
n	110	6E
o	111	6F
p	112	70
q	113	71
r	114	72
s	115	73
t	116	74
u	117	75
v	118	76
w	119	77
x	120	78
y	121	79
z	122	7A
{	123	7B
	124	7C
}	125	7D
~	126	7E
□	127	7F
Reserved	128	8A
	<i>to</i>	<i>to</i>
	159	9F
	160	A0
i	161	A1
¢	162	A2
£	163	A3
€	164	A4
¥	165	A5
§	166	A6
§	167	A7
§	168	A8

Char.	Dec.	Hex.
©	169	A9
ª	170	AA
«	171	AB
¬	172	AC
-	173	AD
®	174	AE
¯	175	AF
°	176	B0
±	177	B1
²	178	B2
³	179	B3
Ž	180	B4
µ	181	B5
¶	182	B6
·	183	B7
ž	184	B8
¹	185	B9
º	186	BA
»	187	BB
Œ	188	BC
œ	189	BD
ÿ	190	BE
ı	191	BF

Char.	Dec.	Hex.
À	192	C0
Á	193	C1
Â	194	C2
Ã	195	C3
Ä	196	C4
Å	197	C5
Æ	198	C6
Ç	199	C7
È	200	C8
É	201	C9
Ê	202	CA
Ë	203	CB
Ì	204	CC
Í	205	CD
Î	206	CE
Ï	207	CF
Ð	208	D0
Ñ	209	D1
Ò	210	D2
Ó	211	D3
Ô	212	D4
Õ	213	D5
Ö	214	D6

Char.	Dec.	Hex.
×	215	D7
Ø	216	D8
Ù	217	D9
Ú	218	DA
Û	219	DB
Ü	220	DC
Ý	221	DD
Þ	222	DE
ß	223	DF
à	224	E0
á	225	E1
â	226	E2
ã	227	E3
ä	228	E4
å	229	E5
æ	230	E6
ç	231	E7
è	232	E8
é	233	E9
ê	234	EA
ë	235	EB
ì	236	EC
í	237	ED

Char.	Dec.	Hex.
î	238	EE
ï	239	EF
ð	240	F0
ñ	241	F1
ò	242	F2
ó	243	F3
ô	244	F4
õ	245	F5
ö	246	F6
÷	247	F7
ø	248	F8
ù	249	F9
ú	250	FA
û	251	FB
ü	252	FC
ý	253	FD
þ	254	FE
ÿ	255	FF

D.2. Control Characters

Char	Definition	Function
SOH	START OF HEADING	A transmission control character used as the first character of a heading of an information message.
STX	START OF TEXT	A transmission control character that precedes a text and that is used to terminate a heading.
ETX	END OF TEXT	A transmission control character that terminates a text.
EOT	END OF TRANSMISSION	A transmission control character used to indicate the conclusion of the transmission of one or more texts.
ENQ	ENQUIRY	A transmission control character used as a request for a response from a remote station; the response may include station identification and/or station status. When a "Who are you" function is required on the general switched transmission network, the first use of ENQ after the connection is established will have the meaning "Who are you" (station identification). Subsequent use of ENQ may, or may not, include the function "Who are you", as determined by agreement.

Char	Definition	Function
ACK	ACKNOWLEDGE	A transmission control character transmitted by a receiver as an affirmative response to the sender.
BEL	BELL	A control character that is used when there is a need to call for attention; it may control alarm or attention devices.
BS	BACKSPACE	A format effector that moves the active position one character position backwards on the same line.
HT	HORIZONTAL TABULATION	A format effector that advances the active position to the next pre-determined character position on the same line.
LF	LINE FEED	A format effector that advances the active position to the same character position of the next line.
VT	VERTICAL TABULATION	A format effector that advances the active position to the same character position on the next pre-determined line.
FF	FORM FEED	A format effector that advances the active position to the same character position on a pre-determined line of the next form or page.
CR	CARRIAGE RETURN	A format effector that moves the active position to the first character position on the same line.
SO	SHIFT OUT	A control character that is used in conjunction with SHIFT IN and ESCAPE to extend the graphic character set of the code.
SI	SHIFT IN	A control character that is used in conjunction with SHIFT OUT and ESCAPE to extend the graphic character set of the code.
DLE	DATA LINK ESCAPE	A transmission control character that will change the meaning of a limited number of contiguously following characters. It is used exclusively to provide supplementary data transmission control functions. Only graphic characters and transmission control characters can be used in DLE sequences.
DC1	DEVICE CONTROL ONE	A device control character that is primarily intended for turning on or starting an ancillary device. If it is not required for this purpose, it may be used to restore a device to the basic mode of operation (see also DC2 and DC3), or for any other device control function not provided by other DCs.
DC2	DEVICE CONTROL TWO	A device control character that is primarily intended for turning on or starting an ancillary device. If it is not required for this purpose, it may be used to set a device to a special mode of operation (in which case DC1 is used to restore normal operation), or for any other device control function not provided by other DCs.

Char	Definition	Function
DC3	DEVICE CONTROL THREE	A device control character that is primarily intended for turning off or stopping an ancillary device. This function may be a secondary level stop, for example, wait, pause, stand-by or halt (in which case DC1 is used to restore normal operation). If it is not required for this purpose, it may be used for any other device control function not provided by other DCs.
DC4	DEVICE CONTROL FOUR	A device control character that is primarily intended for turning off, stopping, or interrupting an ancillary device. If it is not required for this purpose, it may be used for any other device control function not provided by other DCs.
NAK	NEGATIVE ACKNOWLEDGE	A transmission control character transmitted by a receiver as a negative response to the sender.
SYN	SYNCHRONOUS IDLE	A transmission control character used by a synchronous transmission system in the absence of any other character (idle condition) to provide a signal from which synchronism may be achieved or retained between data terminal equipment.
ETB	END OF TRANSMISSION BLOCK	A transmission control character used to indicate the end of a transmission block of data where data is divided into such blocks for transmission purposes.
CAN	CANCEL	A character, or the first character of a sequence, indicating that the data preceding it is in error. As a result, this data is to be ignored. The specific meaning of this character must be defined for each application and/or between sender and recipient.
EM	END OF MEDIUM	A control character that may be used to identify the physical end of a medium, or the end of the used portion of a medium, or the end of the wanted portion of data recorded on a medium. The position of this character does not necessarily correspond to the physical end of the medium.
SUB	SUBSTITUTE	A control character used in the place of a character that has been found to be invalid or in error. SUB is intended to be introduced by automatic means.
ESC	ESCAPE	A control character that is used to provide additional control functions. It alters the meaning of a limited number of contiguously following bit combinations.
FS	FILE SEPARATOR	A control character used to separate and qualify data logically; its specific meaning has to be specified for each application. If this character is used in hierarchical order, it delimits a data item called a file.
GS	GROUP SEPARATOR	A control character used to separate and qualify data logically; its specific meaning has to be specified for each application. If this character is used in hierarchical order, it delimits a data item called a group.

Char	Definition	Function
RS	RECORD SEPARATOR	A control character used to separate and qualify data logically; its specific meaning has to be specified for each application. If this character is used in hierarchical order, it delimits a data item called a record.
US	UNIT SEPARATOR	A control character used to separate and qualify data logically; its specific meaning has to be specified for each application. If this character is used in hierarchical order, it delimits a data item called a unit.

METTLER TOLEDO Service

To protect your METTLER TOLEDO product's future:

Congratulations on choosing the quality and precision of METTLER TOLEDO. Proper use according to these instructions and regular calibration and maintenance by our factory-trained service team ensure dependable and accurate operation, protecting your investment. Contact us about a METTLER TOLEDO service agreement tailored to your needs and budget.

We invite you to register your product at www.mt.com/productregistration so we can contact you about enhancements, updates and important notifications concerning your product.

www.mt.com/IND560x

For more information

Mettler-Toledo, LLC

1900 Polaris Parkway
Columbus, OH 43240
Phone 800 438 4511
Fax 614 438 4900

© 2022 Mettler-Toledo, LLC
72184339 Rev. 12, 08/2022



72184339